



Board of Adjustment Staff Report

Meeting Date: February 2, 2017

Subject: Special Use Permit Case Number WSUP16-0001
Applicants: Burdick Excavating Co., Inc. and Boulder Creek Enterprises
Agenda Item Number: 8A
Project Summary: Special Use Permit for grading and to provide for an overall code compliance plan to terminate operation of the existing unlawful commercial rock quarry
Recommendation: Approval with Conditions
Prepared by: Chad Giesinger, AICP, Senior Planner
Washoe County Community Services Department
Planning and Development Division
Phone: 775.328.3626
E-Mail: cgiesinger@washoecounty.us

Description

Special Use Permit Case Number WSUP16-0001 (Ophir Hill) – Hearing, discussion, and possible action to approve a Special Use Permit for major grading in excess of the 5,000 cubic yards of excavation threshold established in Washoe County Code Section 110.438.35, to grade a total of 416,580 square feet (or 9.56 acres) and excavate a total of 38,834 cubic yards of material, and to provide for an overall code compliance plan pursuant to Washoe County Code Section 125.160 to terminate operation of the existing unlawful commercial rock quarry.

- Applicant/Property Owner: Burdick Excavating Co., Inc. and Boulder Creek Enterprises
- Location: 3270 Old US Highway 395, Washoe Valley
- Assessor's Parcel Numbers: 046-032-02, 046-032-04, 046-032-05
- Parcel Size: 5.29 acres, 2.48 acres, 3.58 acres
- Master Plan Category: Rural (R)
- Regulatory Zone: High Density Rural (HDR)
- Area Plan: South Valley
- Citizen Advisory Board: South Truckee Meadows/Washoe Valley
- Development Code: Authorized in Article 438 (Grading) and Article 810 (Special Use Permits)
- Commission District: 2 – Commissioner Lucey
- Section/Township/Range: Section 34, T17N, R19E, MDM, Washoe County, NV

Staff Report Contents

Project Description..... 1

Special Use Permit 3

Vicinity Map 4

Site Plan 7

Project Evaluation 8

South Truckee Meadows/Washoe Valley Citizen Advisory Board (STMWVCAB)..... 9

Reviewing Agencies.....10

Recommendation.....12

Motion.....12

Appeal Process.....12

Exhibits Contents

Conditions of Approval.....Exhibit A

Agency Comment Letters (6)Exhibit B

Public Notice Map Exhibit C

Project Application Exhibit D

Initial Applicant Code Compliance Plan.....Exhibit E

Applicant Notice to Neighbors to Continue Use.....Exhibit F

Special Use Permit

The purpose of a Special Use Permit is to allow a method of review to identify any potential harmful impacts on adjacent properties or surrounding areas for uses that may be appropriate within a regulatory zone; and to provide for a procedure whereby such uses might be permitted by further restricting or conditioning them so as to mitigate or eliminate possible adverse impacts. If the Board of Adjustment grants an approval of the Special Use Permit, that approval is subject to Conditions of Approval. Conditions of Approval are requirements that need to be completed during different stages of the proposed project. Those stages are typically:

- Prior to permit issuance (i.e. a grading permit, a building permit, etc.)
- Prior to obtaining a final inspection and/or a certificate of occupancy on a structure
- Prior to the issuance of a business license or other permits/licenses
- Some Conditions of Approval are referred to as "Operational Conditions." These conditions must be continually complied with for the life of the business or project.

The Conditions of Approval for Special Use Permit Case Number WSUP16-0001 are attached to this staff report and if the permit is approved will be included with the Action Order.

Vicinity Map

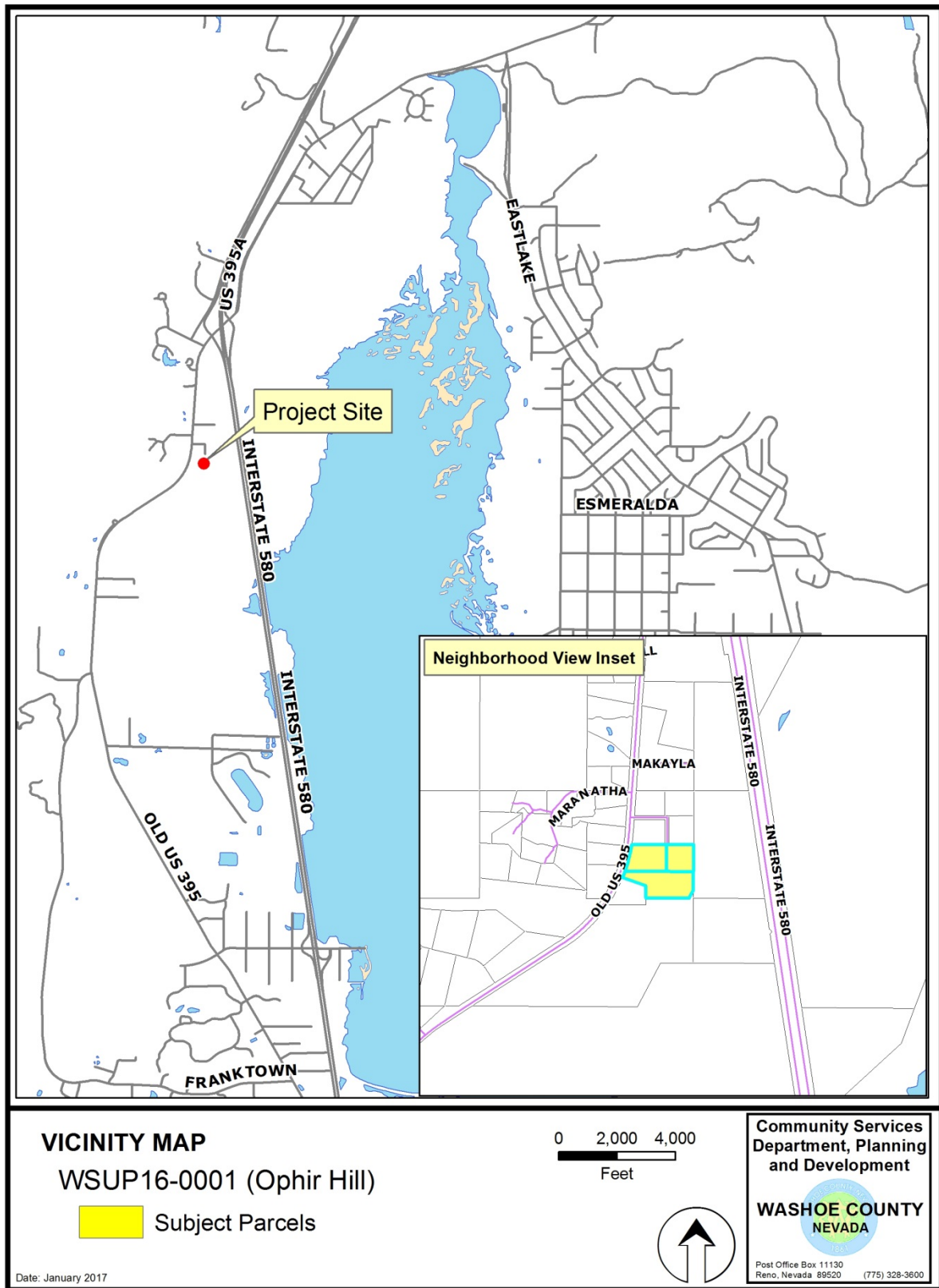

Existing Site Conditions

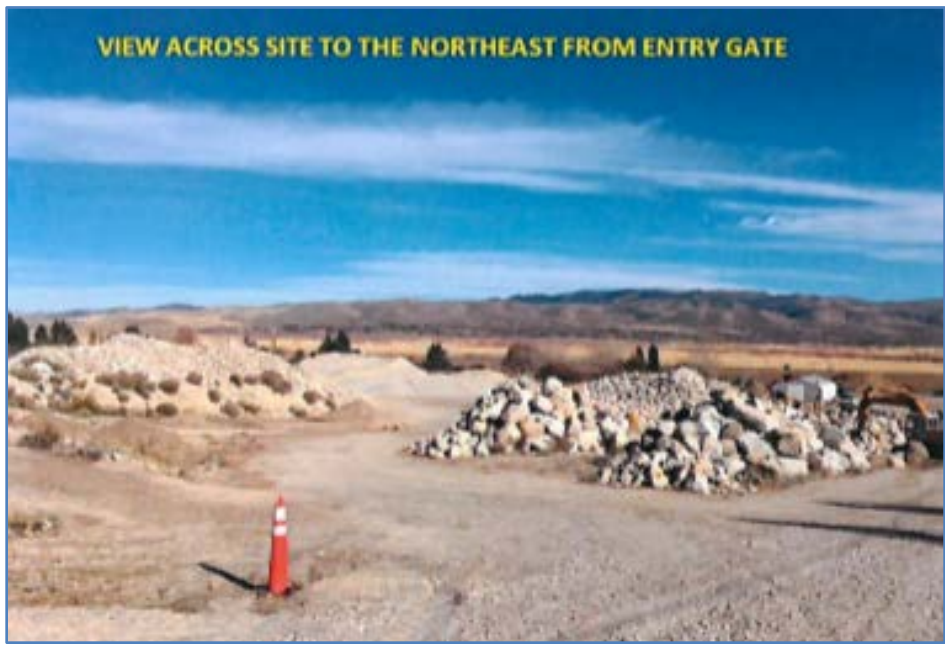

Existing Site Conditions – Material Estimates

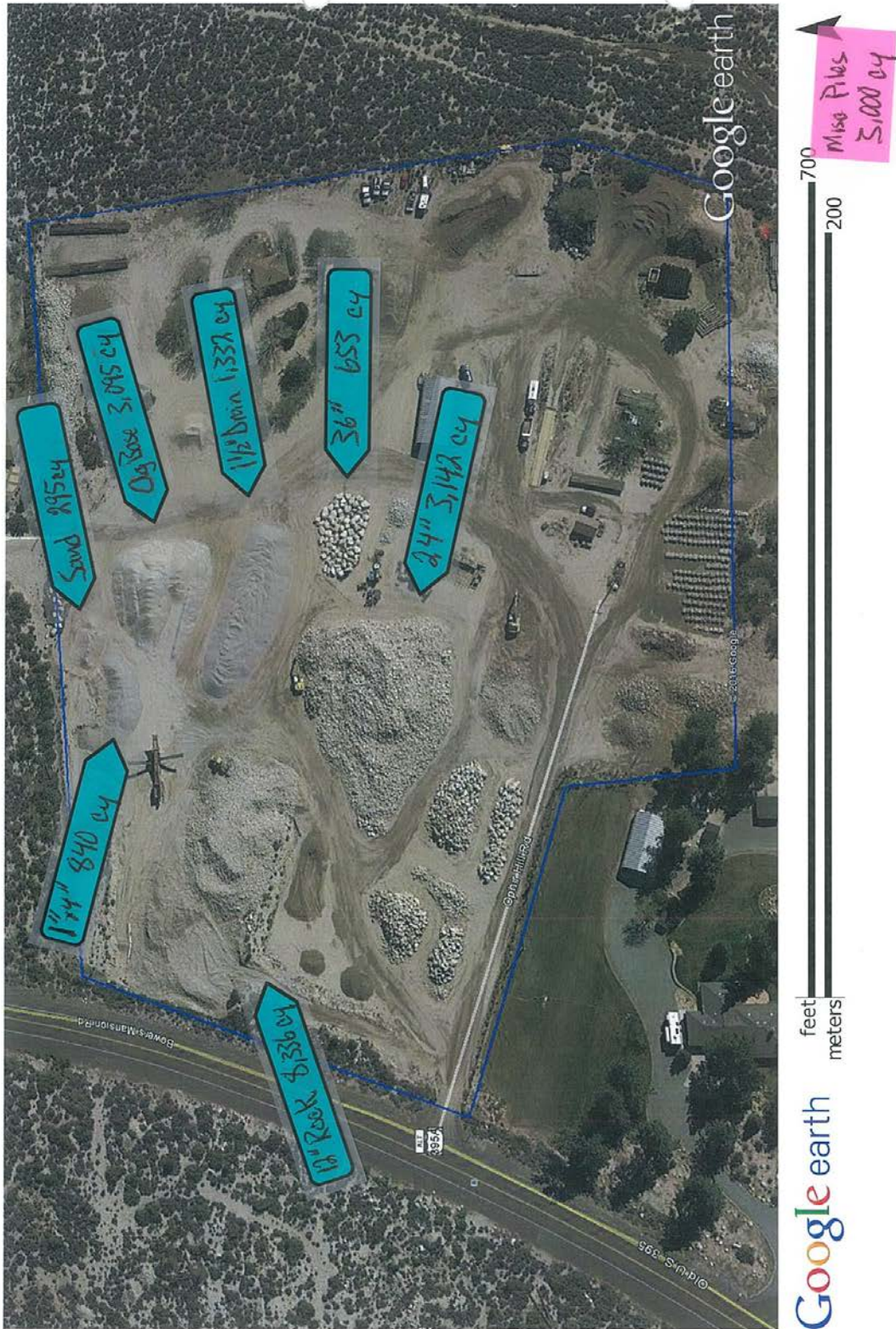

Site Plan



In the above site plan, the gray area is existing aggregate gravel base (to remain), the solid darker lines are proposed 1 foot contours, the light dashed lines are existing contours, and the dark/thicker dashed lines are the limits of disturbance.

Project Evaluation

The subject parcels are located in the northern portion of West Washoe Valley in between Interstate 580 and Old HWY. US 395. All three of the subject parcels are zoned High Density Rural (HDR) within the South Valleys Area Plan. Surrounding land use includes similar single family residential uses to the north, west, and south, and Bureau of Land Management open space land to the east. An existing commercial rock quarry (discussed in more detail below) is currently operating on the site which has resulted in the construction of a 2,000 square foot shop building along with other ancillary uses such as a truck scale, a storage yard area, piles of rock, sheds, and gravel access roads. There is also a 768 square foot single family residence constructed in 1944 on the site.

Although this application is technically a Special Use Permit for Major Grading, the real focus of the request is to establish a code compliance plan to phase out an existing illegal use on the property. The County's Administrative Enforcement Code (WCC Chapter 125) provides a process for property owners in violation of County Code (in this case, WCC Chapter 110) additional time to come into compliance with County Codes through an approved code compliance plan. Elements of the code compliance plan will be developed and included as part of the Special Use Permit for Major Grading approval process and implemented as Conditions of Approval. As part of the code compliance plan, the applicant is proposing to re-grade/re-contour the site to its original pre-disturbance (and pre-landslide) condition. Because of the size of the properties involved and the amount of grading disturbance proposed to return the site to its original condition, the requirements for Major Grading were triggered.

Per WCC Section 110.438.35(a)(1), Major Grading is triggered when grading of more than four (4) acres occurs on a parcel of any size, or, more than 5,000 cubic yards of material is excavated. A total of 416,580 square feet (or 9.56 acres) of overall grading disturbance is proposed. In addition, a total of 38,834 cubic yards of material will be excavated on the site once all of the grading is complete and the code compliance plan is fully implemented. Approximately 110 cubic yards of material (boulders, road base, gravel, sand, etc.) will be exported from the site through continuation of current commercial operations.

As mentioned above, the project site is currently utilized as a commercial rock quarry for large boulders (but no sub-surface excavation or mining occurs onsite). The applicant has stated that many of the onsite boulders are used by Burdick Excavation in Lake Tahoe basin water quality management / restoration projects, as well as other projects in the region. Export to such projects will continue under the code compliance plan. Customers (such as landscaping contractors) may also come to the site and "harvest" boulders (along with sand and aggregate).

The onsite material was deposited across the subject properties as a result of the Slide Mountain landslide that occurred in 1983. For over the past 30 years, the property owners have operated what is essentially an Aggregate Facility to clear the property of the landslide debris through commercial sale of material. An Aggregate Facility, however, is classified as an Industrial (I) use type, which is not an allowed use in the HDR residential regulatory zone and is therefore an illegal use on the property.

A recent code enforcement complaint regarding the use of the property has resulted in code enforcement action by the county. The property owner (Linda Burdick dba Boulder Creek Enterprises) was verbally issued an Administrative Warning (Enforcement Case Number AE-16-0205) in early July of 2016. Because the use has been occurring unabated since the Slide Mountain avalanche in late May of 1983, and may be nearing "completion", staff has worked out an agreement with the applicant and her legal counsel to bring the property into code compliance (i.e. cease all commercial rock quarry activities on all three properties) by ending the illegal use through a phased code compliance plan. The compliance plan will include the

removal of all landslide debris and processed rock (i.e. large boulders, sorted rock, etc.) and the re-grading/re-contouring of the site to its original pre-disturbance (and pre-landslide) condition. Removal of such a large amount of material, though, and the resultant re-grading, will take some time.

Therefore, staff has agreed to a phased compliance plan lasting a maximum of 4-years in duration. The applicant originally requested a 10-year compliance time frame, but staff felt this was too much time to allow the illegal use to continue before achieving code compliance. The applicant then countered with a proposal for 7-years, but staff felt this was also too lengthy. Ultimately a 4-year compliance timeframe was agreed upon, which is not much longer than it can take for an approved grading permit to run its course (i.e. 18 months before expiration and another 18 month extension allowed).

Over the course of the next 4-years, Burdick Excavating will continue to operate the site as currently operated. No new improvements (other than the proposed grading) associated with the commercial use or expansion of operations will be allowed. While operations are ongoing, and as materials are being removed from the site, the overall re-grading plan will be implemented on a phased basis. At the end of 4-years (or sooner if possible), the site will be restored to a natural state and all commercial operations will cease. There may be some remaining boulders that will be strategically placed within the parcels to achieve a natural appearance. The subject parcels will be re-graded in such a way that future conforming single family residential uses can then take place.

The proposed grading plans submitted along with the application appear to meet the requirements of WCC Chapter 110, Article 438, *Grading Standards* (if the SUP is approved, a subsequent grading permit will also be required, reviewed, and approved). Conditions of Approval have been crafted to address elements of and compliance with the agreed upon code compliance plan. Because the Industrial use is illegal, and will now be temporary by agreement, compliance with Industrial parking and landscaping requirements is unnecessary. No new signage is proposed and lighting shall not be allowed on site as part of ongoing operations. *NOTE: The Board of Adjustment is not being asked to authorize this existing illegal use, but rather, to approve a Special Use Permit for Major Grading and an associated code compliance plan that will result in the phased termination of the illegal use.*

Drainage conditions will not be altered by the proposed grading (i.e. the engineering design has incorporated on-site and off-site drainage conditions) and the applicant is proposing to revegetate the re-graded site with native vegetation such as sagebrush, rabbit brush, etc. The applicant has submitted an erosion control plan that details the reseeding and erosion control specifications. Irrigation is available onsite and can be extended from existing water service (which is a well – Water Rights staff has reviewed the application and has no issues, see attached Exhibit B Agency Comment Letters). Hours of operation, lighting, noise, access, traffic, and dust will be addressed by agency review and recommended conditions of approval. Visual impacts from the use will be greatly mitigated by implementation of the code compliance plan and proposed grading restoration. No trees will be removed as part of the grading.

South Truckee Meadows/Washoe Valley Citizen Advisory Board (STM/WV CAB)

Due to inclement weather, the STM/WV CAB did not meet to review and comment on this application until January 25, 2017, which was past the due date for this staff report. The CAB was noticed, however, and provided a copy of the application. Staff had not received any comments from CAB members as of the writing and distribution of this staff report.

Reviewing Agencies

The following agencies received a copy of the project application for review and evaluation:

- Washoe County Community Services Department
 - Planning and Development Division
 - Planning
 - Water Rights Manager
 - Engineering and Capital Projects Division
 - Land Development
 - Traffic
- Washoe County Health District
 - Air Quality
 - Vector-Borne Diseases Division
 - Environmental Health Division
- Truckee Meadows Fire Protection District
- Regional Transportation Commission
- Nevada Department of Transportation (NDOT)
- Nevada Department of Environmental Protection (NDEP)
- Bureau of Land Management, Nevada State Office
- Washoe-Storey Conservation District

Three out of the thirteen above listed agencies/departments provided comments and/or recommended conditions of approval in response to their evaluation of the project application. A **summary** of each agency's comments and/or recommended conditions of approval and their contact information is provided. The Conditions of Approval document is attached to this staff report and will be included with the Action Order if the application is approved by the Board of Adjustment.

- Washoe County Planning and Development Division reviewed the application and recommends approval subject to certain operational and permitting conditions, and under the condition that the site will be returned to a natural state and all commercial operations shall cease by no later than March 1, 2021.
Contact: Chad Giesinger, AICP, Senior Planner, 775.328.3626, cgiesinger@washoecounty.us
- Washoe County Engineering and Capital Projects Division, Land Development responded by recommending conditions requiring detailed plans for grading (to include an erosion control plan), compliance with best management practices (BMP's), a Stormwater Discharge Permit from NDEP, \$2,000/acre grading bond, conformance with NDOT requirements for commercial driveways, an NDOT occupancy permit, and depiction of the FEMA 100-year floodplain on all grading plans.
Contact: Leo Vesely, Engineer, 775.328.2313, ivesely@washoecounty.us
- Washoe County Health District, Environmental Health Services Division responded by requiring the identification of the existing leach septic system (i.e. Tank and Leach Field) for the onsite single family dwelling and "shop". Since this site is currently operating as a commercial site WCHD will also require approval of the proposed use from the State of Nevada Department of Environmental Protection, Bureau of Water Pollution Control.
Contact: Wes Rubio, Senior Environmental Health Specialist, 775.328.2635, wrubio@washoecounty.us

Staff Comment on Required Findings

Washoe County Code Section 110.810.30 requires that all of the following findings be made to the satisfaction of the Washoe County Board of Adjustment before granting approval of the request. Staff has completed an analysis of the special use permit application and has determined that the proposal is in compliance with the required findings as follows.

1. **Consistency.** That the proposed use is consistent with the action programs, policies, standards and maps of the Master Plan and the South Valleys Area Plan.

Staff Comment: Although the existing use and condition of the property is not consistent with the action programs, policies, standards and maps of the Master Plan and the South Valleys Area Plan, implementation of this SUP and associated code compliance plan will bring the subject parcels into consistency. The resulting end state of the properties will enable conforming residential use as envisioned by the Master Plan and the South Valleys Area Plan.

2. **Improvements.** That adequate utilities, roadway improvements, sanitation, water supply, drainage, and other necessary facilities have been provided, the proposed improvements are properly related to existing and proposed roadways, and an adequate public facilities determination has been made in accordance with Division Seven.

Staff Comment: Based on agency review, comments received to date, and proposed conditions of approval, it appears that adequate utilities, roadway improvements, sanitation, water supply, drainage, and other necessary facilities are either available or have been provided.

3. **Site Suitability.** That the site is physically suitable for the type of development and for the intensity of such a development.

Staff Comment: While the rock debris left in the aftermath of the Slide Mountain landslide resulted in the site being physically suitable for the type of development that is currently occurring (i.e. an Aggregate Facility), the subject property and all surrounding properties are not zoned for such a use and are not suitable for the intensity of such a development. Implementation of this SUP and associated code compliance plan, however, will mitigate the unsuitable aspects of the current use and bring the properties into conformance with applicable codes and plans.

4. **Issuance Not Detrimental.** That issuance of the permit will not be significantly detrimental to the public health, safety or welfare; injurious to the property or improvements of adjacent properties; or detrimental to the character of the surrounding area.

Staff Comment: Issuance and implementation of the SUP and associated code compliance plan will correct existing detrimental uses and ensure that the future use/condition of the property will not be significantly detrimental to the public health, safety or welfare; injurious to the property or improvements of adjacent properties; or detrimental to the character of the surrounding area.

5. **Effect on a Military Installation.** Issuance of the permit will not have a detrimental effect on the location, purpose or mission of the military installation.

Staff Comment: There is no military installation within the vicinity. Therefore there is no effect on a military installation.

Recommendation

Those agencies which reviewed the application recommended conditions in support of approval of the project. Therefore, after a thorough analysis and review, Special Use Permit Case Number WSUP16-0001 is being recommended for approval with conditions. Staff offers the following motion for the Board's consideration.

Motion

I move that, after giving reasoned consideration to the information contained in the staff report and information received during the public hearing, the Washoe County Board of Adjustment approve Special Use Permit Case Number WSUP16-0001, with the Conditions of Approval included as Exhibit A for this matter, for Burdick Excavating, having made all five findings in accordance with Washoe County Code Section 110.810.30:

1. Consistency. That the proposed use is consistent with the action programs, policies, standards and maps of the Master Plan and the South Valleys Area Plan;
2. Improvements. That adequate utilities, roadway improvements, sanitation, water supply, drainage, and other necessary facilities have been provided, the proposed improvements are properly related to existing and proposed roadways, and an adequate public facilities determination has been made in accordance with Division Seven;
3. Site Suitability. That the site is physically suitable for the type of development and for the intensity of such a development;
4. Issuance Not Detrimental. That issuance of the permit will not be significantly detrimental to the public health, safety or welfare; injurious to the property or improvements of adjacent properties; or detrimental to the character of the surrounding area;
5. Effect on a Military Installation. Issuance of the permit will not have a detrimental effect on the location, purpose or mission of the military installation.

Appeal Process

Board of Adjustment action will be effective 10 calendar days after the written decision is filed with the Secretary to the Board of Adjustment and mailed to the applicant, unless the action is appealed to the Washoe County Board of County Commissioners, in which case the outcome of the appeal shall be determined by the Washoe County Board of County Commissioners. Any appeal must be filed in writing with the Planning and Development Division within 10 calendar days after the written decision is filed with the Secretary to the Board of Adjustment and mailed to the applicant.

Applicant/Property Owner: Burdick Excavation, Inc.
PO Box 22330
Carson City, NV 89721

Representatives:

Rubicon Design Group, LLC
100 California Ave. Suite 202
Reno, NV 89509

Lumos and Associates, Inc.
800 E. College Pkwy.
Carson City, NV 89706



Conditions of Approval

Special Use Permit Case Number WSUP16-0001

The project approved under Special Use Permit Case Number WSUP16-0001 shall be carried out in accordance with the Conditions of Approval granted by the Board of Adjustment on February 2, 2017. Conditions of Approval are requirements placed on a permit or development by each reviewing agency. These Conditions of Approval may require submittal of documents, applications, fees, inspections, amendments to plans, and more. These conditions do not relieve the applicant of the obligation to obtain any other approvals and licenses from relevant authorities required under any other act or to abide by all other generally applicable Codes, and neither these conditions nor the approval by the County of this project/use override or negate any other applicable restrictions on uses or development on the property.

Unless otherwise specified, all conditions related to the approval of this Special Use Permit shall be met or financial assurance must be provided to satisfy the Conditions of Approval prior to issuance of a grading or building permit. The agency responsible for determining compliance with a specific condition shall determine whether the condition must be fully completed or whether the applicant shall be offered the option of providing financial assurance. All agreements, easements, or other documentation required by these conditions shall have a copy filed with the County Engineer and the Planning and Development Division.

Compliance with the Conditions of Approval related to this Special Use Permit is the responsibility of the applicant, his/her successor in interest, and all owners, assignees, and occupants of the property and their successors in interest. Failure to comply with any of the conditions imposed in the approval of the Special Use Permit may result in the initiation of revocation procedures.

Washoe County reserves the right to review and revise the Conditions of Approval related to this Special Use Permit should it be determined that a subsequent license or permit issued by Washoe County violates the intent of this approval.

For the purpose of conditions imposed by Washoe County, “may” is permissive and “shall” or “must” is mandatory.

Conditions of Approval are usually complied with at different stages of the proposed project. Those stages are typically:

- Prior to permit issuance (i.e., grading permits, building permits, etc.).
- Prior to obtaining a final inspection and/or a certificate of occupancy.
- Prior to the issuance of a business license or other permits/licenses.
- Some “Conditions of Approval” are referred to as “Operational Conditions.” These conditions must be continually complied with for the life of the project or business.

The Washoe County Commission oversees many of the reviewing agencies/departments with the exception of the following agencies.

- **The DISTRICT BOARD OF HEALTH, through the Washoe County Health District, has jurisdiction over all public health matters in the Health District.**

Any conditions set by the Health District must be appealed to the District Board of Health.

FOLLOWING ARE CONDITIONS OF APPROVAL REQUIRED BY THE REVIEWING AGENCIES. EACH CONDITION MUST BE MET TO THE SATISFACTION OF THE ISSUING AGENCY.

Washoe County Planning and Development

1. The following conditions are requirements of the Planning and Development Division, which shall be responsible for determining compliance with these conditions.

Contact Name – Chad Giesinger, 775.328.3626, cgiesinger@washoecounty.us

- a. The applicant shall demonstrate substantial conformance to the plans approved as part of this special use permit.
- b. The applicant shall submit complete construction plans. Grading and erosion control permits shall be issued within **one month** (unless corrections requested by Washoe County need to be worked out) from the date of approval by Washoe County. The applicant shall complete grading plans within the timeframe specified by the approved Special Use Permit.
- c. The applicant shall attach a copy of the action order approving this project to all permit applications (including grading and erosion control permits) applied for as part of this special use permit.
- d. A note shall be placed on all grading and erosion control plans stating:

NOTE

Should any prehistoric or historic remains/artifacts be discovered during site development, work shall temporarily be halted at the specific site and the State Historic Preservation Office of the Department of Museums, Library and Arts shall be notified to record and photograph the site. The period of temporary delay shall be limited to a maximum of two (2) working days from the date of notification.

- e. The applicant shall submit a plan for the control of noxious weeds as part of the grading permit approval. All revegetation of disturbed areas must be accomplished utilizing native shrubs, grasses, and forbs.
- f. The following **Operational Conditions** shall be required for the life of the project:
 1. Failure to comply with the Conditions of Approval shall render this approval null and void. Compliance with this condition shall be determined by the Planning and Development Division.
 2. This special use permit shall remain **in effect until March 1, 2021** (unless it is otherwise revoked prior to that date) after which time it shall expire. **No extension of this timeframe**, either through an Amendment of Conditions or other means, shall be allowed.
 3. The applicant and any successors shall direct any potential purchaser to meet with the Planning and Development Division to review Conditions of Approval prior to the final sale of the site and/or the special use permit. Any subsequent purchaser/operator of the site and/or the special use permit shall notify the Planning and Development Division of the name, address, telephone number, and contact person of the new purchaser/operator within 30 days of the final sale.

4. **By no later than March 1, 2021**, the entire project site (i.e. APN's 046-032-02, 04, and 05) shall be restored to a natural state (per approved grading plans) and **all commercial operations shall cease** (to include the removal of equipment used for commercial purposes). Any remaining large boulders will be strategically placed within the parcels to achieve a natural appearance. The finished grade of all parcels shall be designed to adequately accommodate future residential use.
5. The existing "shop" may remain as an accessory use to an established primary residential use but shall not be used for commercial purposes unless subsequently legally permitted for such use.
6. No sub-surface or pit mining shall occur on the site.
7. The existing commercial aggregate operation may continue to operate "as is" in order to achieve compliance objectives (unless superseded by any of the enclosed conditions otherwise limiting operational parameters). Existing operations may not expand in any way.
8. To mitigate noise and dust impacts to surrounding residential uses, crushing of rock is prohibited. Any activities resulting in substantial dust generation shall include dust mitigation measures.
9. Aggregate Facility operations (e.g. loading or moving of materials, heavy equipment operation, customer access, grading, etc.) shall only occur during daylight hours. In no event shall operations occur earlier than 6 a.m.
10. Aggregate Facility operations shall not include the use of lighting, to include the use of temporary flood lighting from portable equipment.
11. Only materials currently present on the site shall be included in ongoing Aggregate Facility operations and compliance efforts. No new material may be imported to or temporarily stored on site.
12. All loads of material exiting the site shall be tarped and/or treated for dust or loose material.

Washoe County Engineering and Capital Projects

2. The following conditions are requirements of the Engineering and Capital Projects Division, which shall be responsible for determining compliance with these conditions.

Contact Name – Leo Vesely, 775.328.2313, ivesely@washoecounty.us

- a. A complete set of construction improvement drawings, including an on-site grading plan, shall be submitted when applying for a grading permit. Grading shall comply with best management practices (BMP's) and shall include detailed plans for grading, site drainage, erosion control (including BMP locations and installation details), slope stabilization, and mosquito abatement. Placement or removal of any excavated materials shall be indicated on the grading plan. Silts shall be controlled onsite and not allowed onto adjacent property.
- b. The owner/developer shall obtain, from the Nevada Division of Environmental Protection, a Stormwater Discharge Permit for construction and submit a copy to the Engineering Division prior to issuance of a grading permit.
- c. The owner/applicant shall complete and submit the Truckee Meadows Regional Stormwater Quality Management Program Construction Permit Submittal Checklist and Inspection Fee prior to obtaining a grading permit. The County Engineer shall determine compliance with this condition.

- d. A grading bond of \$2,000/acre of disturbed area shall be provided to the Engineering Division prior to any grading.
- e. If the import or export of materials is required (i.e. as part of the site restoration grading plans, not the removal of existing commercial aggregate/boulders for code compliance), then the applicant shall indicate on the plans where the exported material will be taken or where the imported material will be coming from, and a grading permit shall be obtained for the import/export site.
- f. Driveway locations shall conform to NDOT requirements and Washoe County Code Article 436 for commercial driveways.
- g. An approved occupancy permit shall be obtained from the Nevada Department of Transportation (NDOT), for access to, from, or under roads and highways maintained by NDOT and a copy of said permit sent to the Engineering Division.
- h. The FEMA 100-year floodplain shall be shown on the grading plan to the satisfaction of the County Engineer. All grading in these areas shall be in conformance with the Washoe County Code Article 416.

Washoe County Health District

3. The following conditions are requirements of the Health District, which shall be responsible for determining compliance with these conditions. The District Board of Health has jurisdiction over all public health matters in the Health District. Any conditions set by the Health District must be appealed to the District Board of Health.

Contact Name – Wes Rubio, 775.328.2635, wrubio@washoecounty.us

- a. Prior to any Health District approval, the site must identify the existing leach septic system (Tank and Leach Field) for the existing single family dwelling and the “Shop”. Since this site is currently operating as a commercial site WCHD will require an approval of the proposed from the State of Nevada Department of Environmental Protection, Bureau of Water Pollution Control.
 1. A site plan will be required to be submitted to all parties with the accurate location of the existing septic tank and leach line for all buildings with plumbing. Additionally, the site plan must demonstrate that equal repair area exists for all existing septic systems installed meeting current requirements.
 2. WCHD Regulations Governing Sewage, Wastewater, and Sanitation can be located at the link below:
<https://www.washoecounty.us/health/files/regulations/ehs/sws-regs-2013-05-23.pdf>

*** End of Conditions ***



Washoe County
COMMUNITY SERVICES DEPARTMENT
Engineering and Capital Projects Division

Date: December 30, 2016

To: Chad Giesinger, Planning and Development Division

From: Leo R. Vesely, P.E., Engineering and Capitol Projects Division

Re: **WSUP6-0001**
APN 046-032-02, 04 & 05
Ophir Hill Grading (11.35 acres)

Recommended Conditions of Approval

I have reviewed the referenced special use permit and have the following conditions:

1. A complete set of construction improvement drawings, including an on-site grading plan, shall be submitted when applying for a building/grading permit. Grading shall comply with best management practices (BMP's) and shall include detailed plans for grading, site drainage, erosion control (including BMP locations and installation details), slope stabilization, and mosquito abatement. Placement or removal of any excavated materials shall be indicated on the grading plan. Silts shall be controlled on-site and not allowed onto adjacent property.
2. The owner/developer shall obtain from the Nevada Division of Environmental Protection a Stormwater Discharge Permit for construction and submit a copy to the Engineering Division prior to issuance of a grading permit.
3. The owner/applicant shall complete and submit the Truckee Meadows Regional Stormwater Quality Management Program Construction Permit Submittal Checklist and Inspection Fee prior to obtaining a grading/building permit. The County Engineer shall determine compliance with this condition.
4. A grading bond of \$2,000/acre of disturbed area shall be provided to the Engineering Division prior to any grading.
5. If the import or export of materials is required, the applicant shall indicate on the plans where the exported material will be taken or where the imported material will be coming from, and a grading permit shall be obtained for the import/export site.
6. Driveway locations shall conform to NDOT requirements and Washoe County Code Article 436 for commercial driveways.
7. An approved occupancy permit shall be obtained from the Nevada Department of Transportation (NDOT), for access to, from, or under roads and highways maintained by NDOT and a copy of said permit sent to the Engineering Division.

8. The FEMA 100-year floodplain shall be shown on the grading plan to the satisfaction of the County Engineer. All grading in these areas shall be in conformance with the Washoe County Code Article 416.

LRV/lrv



Washoe County COMMUNITY SERVICES DEPARTMENT

December 21, 2016

TO: Chad Giesinger, AICP, Senior Planner, CSD, Planning & Development Division

FROM: Vahid Behmaram, Water Management Planner Coordinator, CSD

V.B.

SUBJECT: Case Number WSUP16-0001 (Ophir Hill)

Project description:

The applicant is proposing the approval of a Special Use Permit for grading in excess of the thresholds established in Section 110.438.35 of the Development Code and to provide for an overall code compliance plan for the existing non-conforming commercial rock quarry operation located at 3270 Old US Highway 395, Washoe Valley APN(s): 046-032-02, 046-032-04, 046-032-04.

The Community Services Department (CSD) recommends approval of this project with the following Water Rights conditions:

- 1) The non-conforming activity began in 1983, before the enactment of Ordinance 586. This ordinance established Washoe County's first water right requirements for all new developments. Therefore, this non-conforming activity may be exempt.
- 2) The new special use permit also provides for a 4 year phasing out of this activity.
- 3) Based on these findings, no water right requirements are imposed for the approval of this Special Use Permit.

**WASHOE COUNTY
HEALTH DISTRICT**
ENHANCING QUALITY OF LIFE

January 6, 2017

Chad Giesinger, Senior Planner
Washoe County Community Services
Planning and Development Division
PO Box 11130
Reno, NV 89520-0027

RE: Ophir Hill; APN 046-032-02, 04, & 05
Special Use Permit; WSUP16-0001

Dear Mr. Giesinger:

The Washoe County Health District, Environmental Health Services Division (Division) Engineering has reviewed the above referenced project. Approval by this Division is subject to the following conditions:

1. The WCHD has reviewed the above proposed special use permit and has the following comments.
2. Prior to any Health District approval, the site must identify the existing leach septic system (Tank and Leach Field) for the SFD and the "Shop". Since this site is currently operating as a commercial site WCHD will require an approval of the proposed from the State of Nevada Department of Environmental Protection, Bureau of Water Pollution Control.
 - a. A site plan will be required to be submitted to all parties with the accurate location of the existing septic tank and leach line for all buildings with plumbing. Additionally, the site plan must demonstrate that equal repair area exists for all existing septic systems installed meeting current requirements.
 - b. WCHD Regulations Governing Sewage, Wastewater, and Sanitation can be located at the link below:
 - c. <https://www.washoecounty.us/health/files/regulations/ehs/sws-regs-2013-05-23.pdf>

If you have any questions or would like clarification regarding the foregoing, please contact Wes Rubio, Senior Environmental Health Specialist at wrubio@washoecounty.us regarding all Health District comments.

Sincerely,



Bob Sack, Division Director
Environmental Health Services Division
Washoe County Health District

BS:wr





REGIONAL TRANSPORTATION COMMISSION

Metropolitan Planning · Public Transportation & Operations · Engineering & Construction

Metropolitan Planning Organization of Washoe County, Nevada

December 21, 2016

FR: Chrono/PL 183-16

Mr. Roger Pelham, Senior Planner
Community Services Department
Washoe County
P.O. Box 11130
Reno, NV 89520

**RE: WADMIN16-0001 (Mays Building)
WPVAR16-0001 (Meyer-McSherry)
WPVAR16-0002 (Sierra RV Storage Lot)
WPVAR16-0003 (Snyder Residence)
WSUP16-0001 (Ophir Hill)**

Dear Mr. Roger Pelham,

We have reviewed the above applications and have no comments at this time.

Thank you for the opportunity to comment on these applications. Please feel free to contact me at 775-332-0174 or rkapuler@rtcwashoe.com if you have any questions or comments.

Sincerely,

Rebecca Kapuler
Planner

RK

Copies: Bill Whitney, Washoe County Community Services
Chad Giesinger, Washoe County Community Services
Eva Krause, Washoe County Community Services
Jae Pullen, Nevada Department of Transportation, District II
Tina Wu, Regional Transportation Commission
Daniel Doenges, Regional Transportation Commission
Julie Masterpool, Regional Transportation Commission
David Jickling, Regional Transportation Commission

/Washoe County no comment 01032017

Traffic_No_Comment.txt

From: Lawson, Clara
Sent: Tuesday, January 03, 2017 10:25 AM
To: Giesinger, Chad
Cc: Vesely, Leo
Subject: Ophir Hill - WSUP16-0001

I don't see any traffic issues with this project

Clara Lawson, PE, PTOE, Licensed Engineer
Washoe County | Community Services Dept | Engineering Division 1001 E. Ninth
St., Reno NV
89520

cclawson@washoecounty.us | o 775-328-3603 | fax 775-328-3699

Connect with us: cMail | Twitter | Facebook | www.washoecounty.us



STATE OF NEVADA
DEPARTMENT OF TRANSPORTATION

District II
310 Galletti Way
Sparks, Nevada 89431
(775) 834-8300 FAX (775) 834-8319

December 23, 2016

BRIAN SANDOVAL
Governor

RUDY MALFABON, P.E., Director

Washoe County
Planning and Development Division
P.O. Box 11130
Reno, NV 89520-0027

WSUP16-0001
Ophir Hill
US 395A, Old US 395

Attention: Mr. Chad Giesinger, Senior Planner

Dear Mr. Giesinger:

I have reviewed the request to approve a Special Use Permit for grading in excess of the thresholds established in Section 110.438.35 of the Development Code and to provide for an overall code compliance plan for the existing nonconforming commercial rock quarry operation. (3270 Old US Highway 395, Washoe Valley / APN 046-032-02, 046-032-04, 046-032-04 / Burdick Excavating Co., Inc. & Boulder Creek Enterprises).

Since there is no change in use or development improvements on the property, NDOT does not have any immediate concerns or comments. The supplied SUP documentation states this approval is the first step (4 year plan) in reaching compliance with the County regarding the grading permit requirements.

Thank you for the opportunity to review this development proposal. NDOT reserves the right to incorporate further changes and/or comments as the design review advances. I look forward to working with you and your team, and completing a successful project. Please feel free to contact me at (775)834-8300, if you have any further questions or comments.

Sincerely,

DocuSigned by:
Jae Pullen
DC6D2FB6D948439...

12/23/2016

Jae Pullen, PE, PTOE
District II Engineering Services

cc: Thor Dyson, District Engineer
File

DS
TD

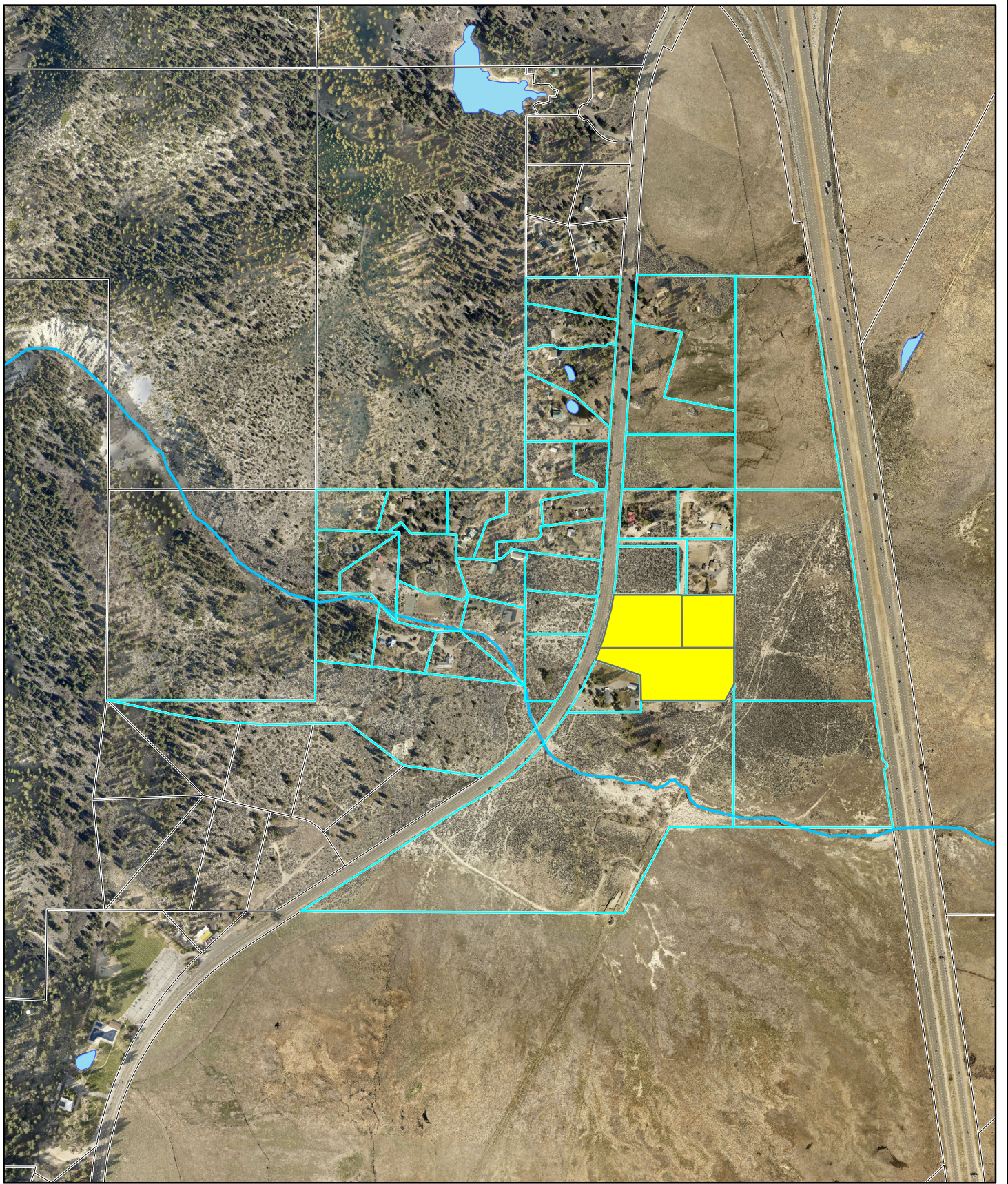

WPSUP16-0001 Public Notice Map
 Parcels noticed within 500 feet of subject property (30 pcls. min.)

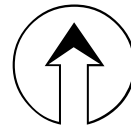

- Noticed Parcels
- Subject Parcel

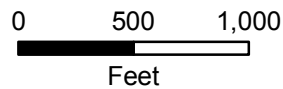

Source: Planning and Development Date: December, 2016

**Community Services
 Department, Planning
 and Development**

**WASHOE COUNTY
 NEVADA**

Post Office Box 333
 Reno, Nevada 89502 **WPSUP16-0001**

EXHIBIT C

OPHIR HILL

SPECIAL USE PERMIT APPLICATION



Photo credit: summitpost.org

PREPARED BY:



NOVEMBER 15, 2016

**WSUP16-0001
EXHIBIT D**

Job # 191-22

OPHIR HILL

SPECIAL USE PERMIT APPLICATION

Prepared for:

Burdick Excavating

Attention: Linda Burdick

PO Box 22330

Carson City, Nevada 89721

Prepared by:

Rubicon Design Group, LLC

100 California Avenue, Suite 202

Reno, Nevada 89509

(775) 425-4800

November 15, 2016

Table of Contents

Introduction 1
Project Location 1
Existing Conditions..... 2
Request Summary..... 4
Special Use Permit Findings..... 6

List of Figures:

Figure 1 – Vicinity Map 1
Figure 2 – Aerial View 2
Figure 3 – Existing Conditions..... 3
Figure 4 – Site/Grading Plan 5

Appendices:

- Washoe County Development Application
- Owner Affidavit
- Special Use Permit Application
- Property Tax Verification
- Preliminary Title Report (Original Only)

OPHIR HILL

Introduction

This application includes the following request:

- A **Special Use Permit** to allow for grading that exceeds the thresholds outlined in Section 110.438.35 of the Washoe County Development Code.

Project Location

Ophir Hill consists of three parcels (APN #'s 046-032-02, 04 and 05) totaling 11.35± acres and is located at 3270 Old US Highway 395 in west Washoe Valley. Specifically, the property is located on the east side of Old US 395, south of Ophir Hill Road, west of Interstate 580. Figure 1 (below) depicts the project location.



Figure 1 – Vicinity Map

OPHIR HILL

Existing Conditions

Currently, the project site is utilized as a rock quarry for large boulders. Unlike a conventional quarry, no mining occurs on the site. Instead, boulders are harvested from those that were deposited onsite as a result of the Slide Mountain landslide that occurred in 1983. There are existing piles of boulders, gravel, sand and aggregate base located onsite.

The existing quarry activities have resulted in the construction of a 2,000± square foot shop building along with other ancillary uses such as a truck scale, storage yards, etc. The site also includes a 768± square foot single family residence (APN # 046-032-04) that was constructed in 1944.

All three of the subject parcels are zoned High Density Rural within the South Valleys Area Plan. Surrounding land use includes single family residential to the north, west and south, with open pasture land to the east.

Figure 2 (below) provides an enlarged aerial view of the site while Figure 3 (following page) depicts the existing onsite conditions.

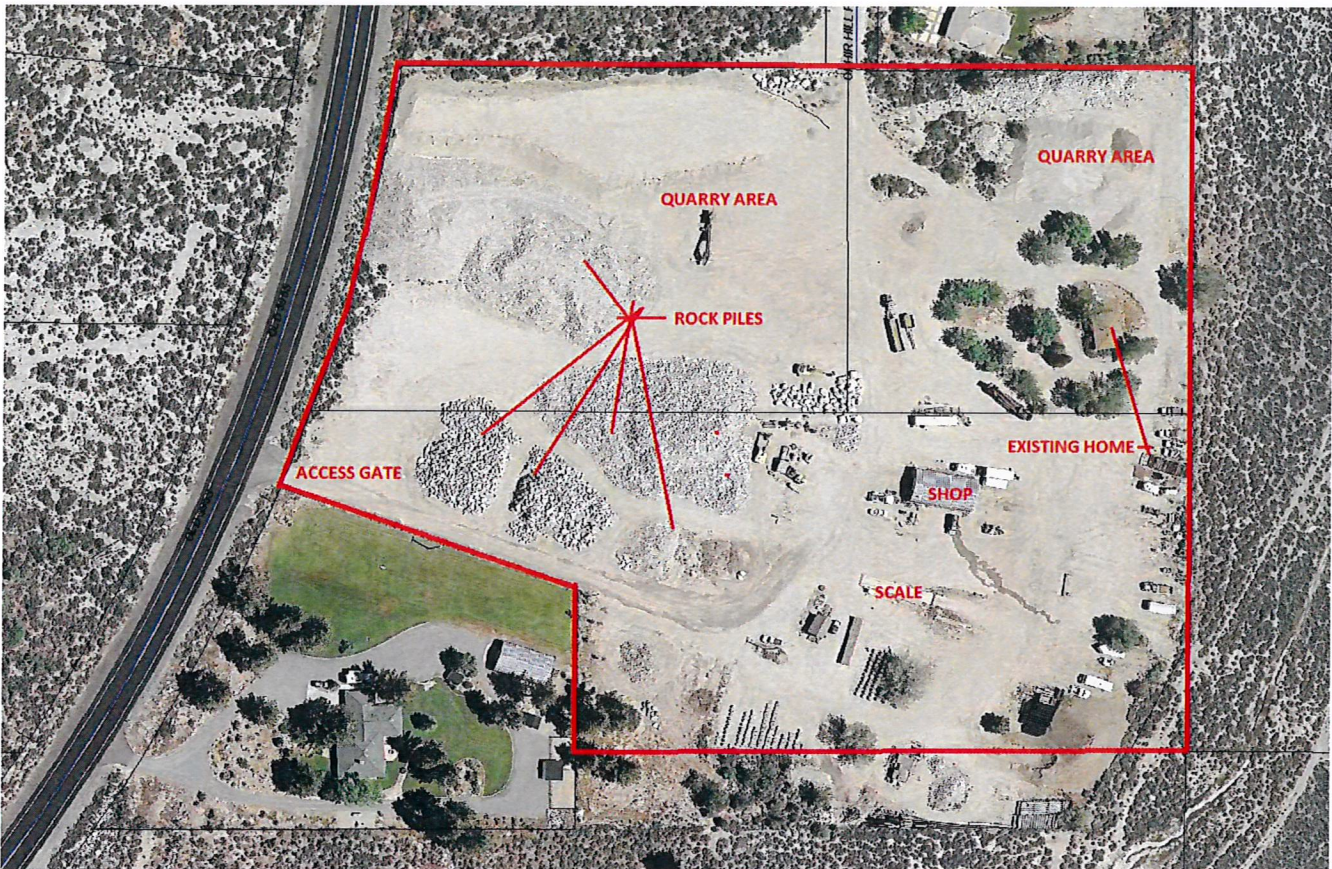

Figure 2 – Aerial View

OPHIR HILL

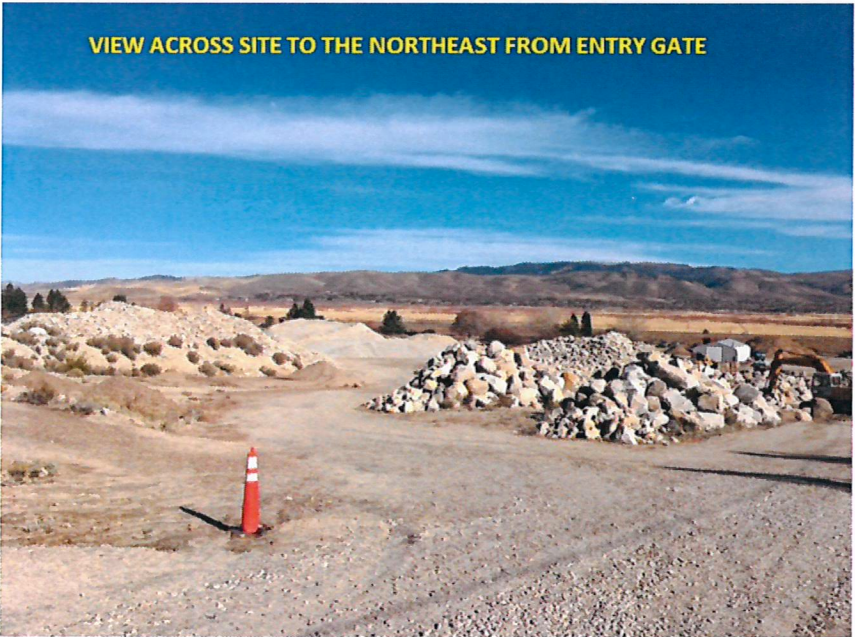
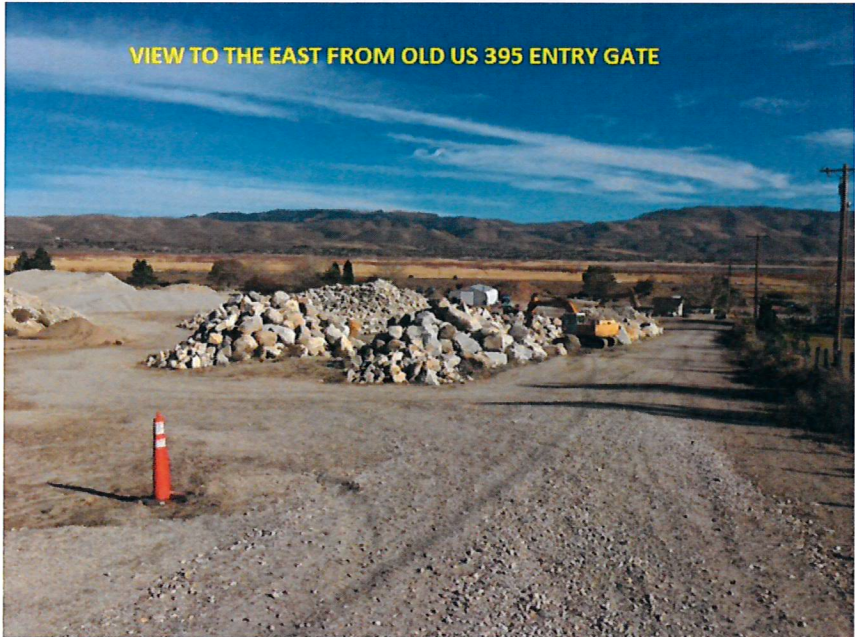

Figure 3 – Existing Conditions

OPHIR HILL

Request Summary

The Special Use Permit (SUP) included with this application serves two primary purposes. First, the SUP will allow for grading in excess of the thresholds established in Section 110.438.35 of the Washoe County Development Code. As proposed, a total of 416,580± square feet of overall grading disturbance will occur. Additionally, a total of 38,834± cubic yards of material will be moved once all the grading is complete. As a result, this constitutes a “Major Grading Permit” per Washoe County Development Code standards.

The second SUP component is to provide for an overall compliance plan for the existing quarry operations. Currently, the rock quarry operations at the site are not a permitted use. However, since these operations have been occurring for well over 30 years, Washoe County has agreed that a time-certain phase-out plan is required for the commercial operations and that the properties be brought into compliance with current County codes and standards.

The Slide Mountain landslide which occurred Memorial Day weekend 1983 deposited approximately 160,000 cubic yards of dirt and materials on to the subject parcel. This included hundreds of large boulders. Since that time, Burdick Excavating has been harvesting these boulders for use in landscaping and public works projects. Unlike a conventional quarry, no mining occurs at the site. Instead, the boulders have been collected and sorted by size, use type, etc. Also, some have been crushed into gravel and aggregate base. As part of this process, grading of the site has occurred but no pits or extensive grading has occurred.

In August 2016, Burdick Excavating was notified by Washoe County that the grading which has occurred over a series of years at the site triggers a Major Grading Permit (which includes a SUP) and that the current operations were not a permitted use. In working with Washoe County staff, including Code Enforcement, Engineering and Planning, it was determined that Burdick Excavating needed to submit a SUP for grading as well as provide an overall compliance plan.

At the recommendation of Washoe County, a 4-year compliance plan is proposed for the site. Essentially, the grading plan included with this SUP provides for a “smoothing-out” of the overall site, resulting in a pre-landslide site condition. Over the course of the next 4 years, Burdick Excavating will continue to operate. Thus, the onsite rockpiles will be significantly reduced as customers and contractors will continue to gather boulders from the property. While these operations are occurring, the overall grading plan will be implemented on a phased basis. Thus, at the end of 4 years, the site will be restored to a natural state and commercial operations will cease. Any remaining boulders will be strategically placed within the parcels to achieve a natural appearance.

Figure 4 (following page) provides an overall site grading plan that depicts how the site will be recontoured at the 4-year phase out of the quarry. The grading required to complete this plan triggers the SUP thresholds noted previously but serves to blend the site and any future use (i.e. single family residential) with surrounding properties and conditions.

OPHIR HILL

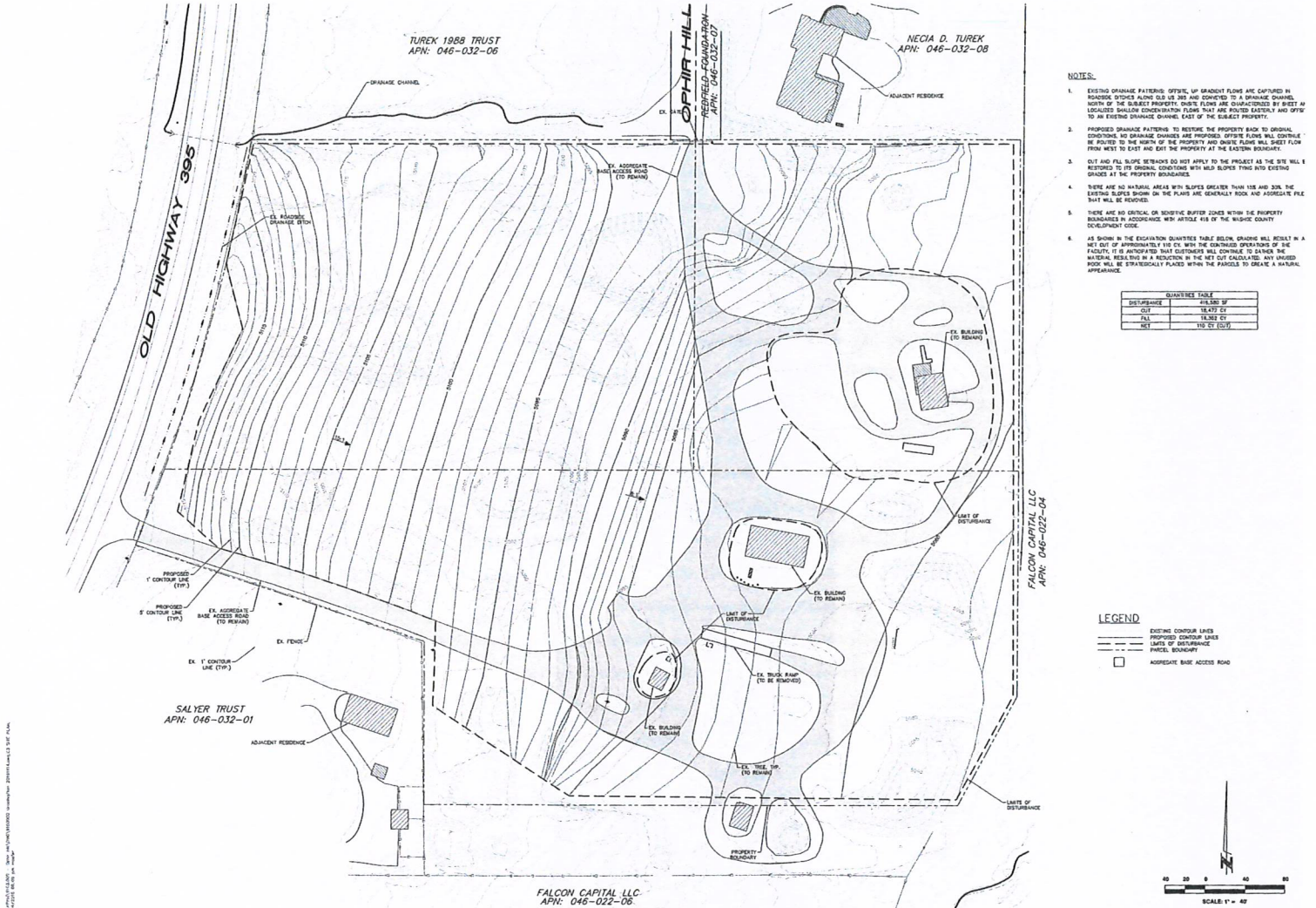

Figure 4 – Site/Grading Plan

OPHIR HILL

Implementation of the grading plan included with this SUP will benefit the surrounding properties by creating a natural appearance and providing for future single family use that is complementary to those surrounding the parcels. Although the commercial operations have operated for over 3 decades without detrimental impact, recountouring of the site will result in far less impacts than what is currently occurring. Furthermore, it brings all 3 subject parcels into full compliance with applicable Washoe County codes and requirements.

Special Use Permit Findings

In order to approve a Special Use Permit, the following findings must be made. Responses are provided in **bold**.

1. Consistency. The granting of the special use permit is consistent with the policies and maps of the Comprehensive Plan Elements and the Area Plan in which the property is located.

Granting of this SUP will ensure that the site is returned to a natural condition and that all uses are permitted within the base zoning district. Additionally, it will provide for conformance with all existing Development Code requirements. Thus, this finding will be met.

2. Adequate Public Facilities. Adequate utilities, roadway improvements, sanitation, water supply, drainage, and other necessary facilities must exist or will be provided.

No new development is proposed at this time other than grading of the site to a natural condition. Therefore, the project is consistent with this finding.

3. Site Suitability. The site must be physically suitable for the proposed use and for the intensity of development.

Grading of the site, as proposed, ensures a natural appearance and will ultimately remove a commercial use. No development (new construction) is proposed. The remaining onsite boulders which are a result of the 1983 landslide will be removed and/or relocated to create a natural appearance. This will set the groundwork for future single family use, consistent with the underlying HDR zoning and surrounding properties.

4. Issuance Not Detrimental. Issuance of the permit may not be significantly detrimental to the public health, safety or welfare; have a detrimental impact on adjacent properties; or be detrimental to the character of the surrounding area.

Granting this permit will have positive impacts on surrounding properties by significantly reducing the intensity of the onsite use and returning the parcels to a natural state which is consistent with the character of the surrounding area.

APPENDICES

Washoe County Development Application

Your entire application is a public record. If you have a concern about releasing personal information, please contact Planning and Development staff at 775.328.3600.

Project Information		Staff Assigned Case No.: _____	
Project Name: Ophir Hill			
Project Description: A SUP to allow for grading that exceeds the thresholds outlined in Section 110.438.35 of the Washoe County Development Code			
Project Address: 3270 Old US Highway 395, Washoe Valley			
Project Area (acres or square feet): 11.35 acres			
Project Location (with point of reference to major cross streets AND area locator): The property is located on the east side of Old US 395, west of I-580, south of Ophir Hill Road.			
Assessor's Parcel No.(s):	Parcel Acreage:	Assessor's Parcel No.(s):	Parcel Acreage:
046-032-02	5.29 acres	046-032-04	2.48 acres
046-032-05	3.58 acres		
Section(s)/Township/Range: Section 34, T17N, R19E			
Indicate any previous Washoe County approvals associated with this application: Case No.(s).			
Applicant Information (attach additional sheets if necessary)			
Property Owner:		Professional Consultant:	
Name: Burdick Excavating Co., Inc. and Boulder Creek Enterprises		Name: Rubicon Design Group, LLC	
Address: PO Box 22330, Carson City, NV		Address: 100 California Ave. Suite 202, Reno, NV	
Zip: 89721		Zip: 89509	
Phone: 775-297-4566 Fax:		Phone: 775-425-4800 Fax:	
Email: LBurdick@BurdickExc.com		Email: mrailey@rubicondesigngroup.com	
Cell: Same as above Other:		Cell: 775-250-3455 Other:	
Contact Person: Linda Burdick		Contact Person: Mike Railey	
Applicant/Developer:		Other Persons to be Contacted:	
Name: Same as above		Name: Lumos & Associates, Inc	
Address:		Address: 800 E. College Pkwy., Carson City, NV	
Zip:		Zip: 89706	
Phone: Fax:		Phone: 775-883-7077 Fax:	
Email:		Email: jferrin@LumosInc.com	
Cell: Other:		Cell: Other:	
Contact Person:		Contact Person: Jason Ferrin, P.E.	
For Office Use Only			
Date Received: Initial:		Planning Area:	
County Commission District:		Master Plan Designation(s):	
CAB(s):		Regulatory Zoning(s):	

Special Use Permit Application Supplemental Information

(All required information may be separately attached)

Chapter 110 of the Washoe County Code is commonly known as the Development Code. Specific references to special use permits may be found in Article 810, Special Use Permits.

1. What is the type of project being requested?

A SUP is being requested to allow for grading in excess of the thresholds established in Section 110.438.35 of the Washoe County Development Code. Refer to attached report for a detailed project description.

2. What currently developed portions of the property or existing structures are going to be used with this permit?

The entire project site is essentially included with the request. This includes the existing quarry and associated buildings/facilities. Refer to attached report for a detailed explanation.

3. What improvements (e.g. new structures, roadway improvements, utilities, sanitation, water supply, drainage, parking, signs, etc.) will have to be constructed or installed and what is the projected time frame for the completion of each?

No new improvements are proposed. Rather, the site will be graded back to a natural state of the course of four years. Refer to attached report for a highly detailed description.

4. What is the intended phasing schedule for the construction and completion of the project?

It is anticipated that the project will be completed over the course of 4 years.

5. What physical characteristics of your location and/or premises are especially suited to deal with the impacts and the intensity of your proposed use?

The proposed grading will have a positive impact on the area by ultimately removing an industrial use (quarry) and returning the property to a natural state. This would then allow for future residential use consistent with the existing HDR zoning and surrounding properties.

6. What are the anticipated beneficial aspects or effects your project will have on adjacent properties and the community?

The project will remove the existing industrial use and return the property to a natural state. It can then be used for future residential use(s) consistent with the existing HDR zoning and surrounding properties. Refer to attached report for a detailed analysis.

7. What will you do to minimize the anticipated negative impacts or effects your project will have on adjacent properties?

Not applicable. This project is anticipated to greatly enhance the aesthetics of the site and the surrounding area in general. Refer to attached report for a detailed impact analysis.

8. Please describe operational parameters and/or voluntary conditions of approval to be imposed on the project special use permit to address community impacts:

The overall site will essentially phase-out the existing quarry operations over the course of 4 years. Therefore, operations will continue as they exist today with grading occurring as the quarry operations become less and less. Refer to attached report for additional details.

9. How many improved parking spaces, both on-site and off-site, are available or will be provided? (Please indicate on site plan.)

Not applicable. Parking for employees will remain as it exists today until quarry operations cease.

10. What types of landscaping (e.g. shrubs, trees, fencing, painting scheme, etc.) are proposed? (Please indicate location on site plan.)

No formal landscaping is being proposed at this time. Instead, revegetation will be used as necessary to return the property to a natural state.

11. What type of signs and lighting will be provided? On a separate sheet, show a depiction (height, width, construction materials, colors, illumination methods, lighting intensity, base landscaping, etc.) of each sign and the typical lighting standards. (Please indicate location of signs and lights on site plan.)

No new signage is proposed.

12. Are there any restrictive covenants, recorded conditions, or deed restrictions (CC&Rs) that apply to the area subject to the special use permit request? (If so, please attach a copy.)

<input type="checkbox"/> Yes	<input checked="" type="checkbox"/> No
------------------------------	--

13. Utilities:

a. Sewer Service	Septic
b. Electrical Service	NV Energy
c. Telephone Service	AT&T/Charter Communications
d. LPG or Natural Gas Service	Propane
e. Solid Waste Disposal Service	Waste Management
f. Cable Television Service	AT&T/Charter Communications
g. Water Service	Well

For most uses, the Washoe County Code, Chapter 110, Article 422, Water and Sewer Resource Requirements, requires the dedication of water rights to Washoe County. Please indicate the type and quantity of water rights you have available should dedication be required:

h. Permit #		acre-feet per year	
i. Certificate #		acre-feet per year	
j. Surface Claim #		acre-feet per year	
k. Other #		acre-feet per year	

l. Title of those rights (as filed with the State Engineer in the Division of Water Resources of the Department of Conservation and Natural Resources):

Not applicable to this request. The property will continue to be served by an existing onsite well.

14. Community Services (provided and nearest facility):

a. Fire Station	TMFPD Station 30
b. Health Care Facility	St. Mary's Urgent Care – Galena
c. Elementary School	Pleasant Valley
d. Middle School	Pine
e. High School	Galena
f. Parks	Davis Creek Regional Park
g. Library	South Valleys
h. Citifare Bus Stop	N/A

Special Use Permit Application for Grading Supplemental Information

(All required information may be separately attached)

Chapter 110 of the Washoe County Code is commonly known as the Development Code. Specific references to special use permits may be found in Article 810, Special Use Permits. Article 438, Grading, and Article 418, Significant Hydrologic Resources, are the ordinances specifically involved in this request.

1. What is the purpose of the grading?

The proposed grading will allow the existing rocks and boulders deposited from the Slide Mountain slide to be removed and for quarry operations to cease, returning the site to a natural state. Refer to attached report for a detailed description.

2. How many cubic yards of material are you proposing to excavate on site?

38,834± cubic yards

3. How many square feet of surface of the property are you disturbing?

416,580± square feet

4. How many cubic yards of material are you exporting or importing? If none, how are you managing to balance the work on-site?

There will be approximately 110 cubic yards of export which will be existing material removed by customers (i.e. boulders, road base, gravel, sand, etc.).

5. Is it possible to develop your property without surpassing the grading thresholds requiring a Special Use Permit? (Explain fully your answer.)

In order to return the parcels to a natural state, the grading is necessary. Refer to attached report for a detailed description/analysis.

6. Has any portion of the grading shown on the plan been done previously? (If yes, explain the circumstances, the year the work was done, and who completed the work.)

Grading has been occurring onsite as a result of the 1983 landslide that deposited a massive amount of boulders and debris on to the properties. The site has been operating as a quarry since that time. Refer to attached report for a detailed description.

7. Have you shown all areas on your site plan that are proposed to be disturbed by grading? (If no, explain fully your answer.)

Yes. Refer to attached engineering plans.

8. Can the disturbed area be seen from off-site? If yes, from which directions, and which properties or roadways?

Disturbed areas will be visible from Old US 395. However, once complete, the site will be returned to a natural state, enhancing aesthetics within the area.

9. Could neighboring properties also be served by the proposed access/grading requested (i.e. if you are creating a driveway, would it be used for access to additional neighboring properties)?

Not applicable.

10. What is the slope (Horizontal:Vertical) of the cut and fill areas proposed to be? What methods will be used to prevent erosion until the revegetation is established?

No slopes greater than 3:1 are proposed in the after condition. Refer to attached grading plan for specifics.

11. Are you planning any berms?

<input type="checkbox"/> Yes	<input checked="" type="checkbox"/> No	If yes, how tall is the berm at its highest?
------------------------------	--	--

12. If your property slopes and you are leveling a pad for a building, are retaining walls going to be required? If so, how high will the walls be and what is their construction (i.e. rockery, concrete, timber, manufactured block)?

Not applicable.

13. What are you proposing for visual mitigation of the work?

This request will greatly enhance aesthetics within the area and will ultimately remove the quarry use. Refer to attached report for specific details.

14. Will the grading proposed require removal of any trees? If so, what species, how many and of what size?

Not applicable.

15. What type of revegetation seed mix are you planning to use and how many pounds per acre do you intend to broadcast? Will you use mulch and, if so, what type?

The site will be reseeded with natural vegetation such as sagebrush, rabbit brush, etc. Refer to attached erosion control plan for specific details and specifications.

16. How are you providing temporary irrigation to the disturbed area?

Temporary irrigation can be extended from existing onsite water service, as/if needed.

17. Have you reviewed the revegetation plan with the Washoe Storey Conservation District? If yes, have you incorporated their suggestions?

The WSCD will review the SUP request and provide comments and/or conditions that can be included on the final permit approval.

18. Are there any restrictive covenants, recorded conditions, or deed restrictions (CC&Rs) that may prohibit the requested grading?

<input type="checkbox"/> Yes	<input checked="" type="checkbox"/> No	If yes, please attach a copy.
------------------------------	--	-------------------------------

Account Detail

[Back to Search Results](#)

[Change of Address](#)

[Print this Page](#)

Washoe County Parcel Information		
Parcel ID	Status	Last Update
04603202	Active	11/15/2016 2:10:14 AM
Current Owner: BURDICK EXCAVATING COMPANY INC PO BOX 22330 CARSON CITY, NV 89721		SITUS: 632 US HIGHWAY 395 S WASHOE COUNTY NV
Taxing District: 4000		Geo CD:
Legal Description Block Range 19 SubdivisionName _UNSPECIFIED Township 17 Section 34 Lot		

Tax Bill (Click on desired tax year for due dates and further details)					
Tax Year	Net Tax	Total Paid	Penalty/Fees	Interest	Balance Due
2016	\$1,422.98	\$711.50	\$0.00	\$0.00	\$711.48
2015	\$1,420.14	\$1,420.14	\$0.00	\$0.00	\$0.00
2014	\$1,376.10	\$1,376.10	\$0.00	\$0.00	\$0.00
2013	\$1,336.02	\$1,361.02	\$0.00	\$0.00	\$0.00
2012	\$1,282.16	\$1,294.98	\$0.00	\$0.00	\$0.00
Total					\$711.48

Important Payment Information

- ALERTS:** If your real property taxes are delinquent, the search results displayed may not reflect the correct amount owing. Please contact our office for the current amount due.
- For your convenience, online payment is available on this site. E-check payments are accepted without a fee. However, a service fee does apply for online credit card payments. See Payment Information for details.

Pay Online

Payments will be applied to the oldest charge first.

Select a payment option:

Total Due \$711.48

Oldest Due \$355.74

Partial

[ADD TO CART](#)

\$0.00

Pay By Check

Please make checks payable to:
WASHOE COUNTY TREASURER

Mailing Address:
P.O. Box 30039
Reno, NV 89520-3039

Overnight Address:
1001 E. Ninth St., Ste D140
Reno, NV 89512-2845

- Payment Information**
- Special Assessment District**
- Installment Date Information**
- Assessment Information**

The Washoe County Treasurer's Office makes every effort to produce and publish the most current and accurate information possible. No warranties, expressed or implied, are provided for the data herein, its use, or its interpretation. If you have any questions, please contact us at (775) 328-2510 or tax@washoecounty.us

This site is best viewed using Google Chrome, Internet Explorer 11, Mozilla Firefox or Safari.

Account Detail

[Back to Search Results](#)

[Change of Address](#)

[Print this Page](#)

Washoe County Parcel Information

Parcel ID	Status	Last Update
04603205	Active	11/15/2016 2:10:14 AM
Current Owner: BOULDER CREEK ENTERPRISES PO BOX 22330 CARSON CITY, NV 89721		SITUS: 3250 S VIRGINIA ST WCTY NV
Taxing District 4000	Geo CD:	
Legal Description		
Township 17 SubdivisionName _UNSPECIFIED Section 34 Range 19		

Tax Bill (Click on desired tax year for due dates and further details)

Tax Year	Net Tax	Total Paid	Penalty/Fees	Interest	Balance Due
2016	\$888.04	\$444.02	\$0.00	\$0.00	\$444.02
2015	\$886.26	\$886.26	\$0.00	\$0.00	\$0.00
2014	\$858.78	\$867.37	\$0.00	\$0.00	\$0.00
2013	\$833.76	\$833.76	\$0.00	\$0.00	\$0.00
2012	\$800.16	\$808.16	\$0.00	\$0.00	\$0.00
Total					\$444.02

Important Payment Information

- **ALERTS:** If your real property taxes are delinquent, the search results displayed may not reflect the correct amount owing. Please contact our office for the current amount due.
- For your convenience, online payment is available on this site. E-check payments are accepted without a fee. However, a service fee does apply for online credit card payments. See Payment Information for details.

Pay Online

Payments will be applied to the oldest charge first.

Select a payment option:

- Total Due \$444.02
 Oldest Due \$222.01
 Partial

[ADD TO CART](#)

\$0.00

Pay By Check

Please make checks payable to:
WASHOE COUNTY TREASURER

Mailing Address:
P.O. Box 30039
Reno, NV 89520-3039

Overnight Address:
1001 E. Ninth St., Ste D140
Reno, NV 89512-2845

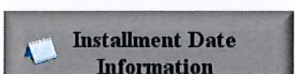
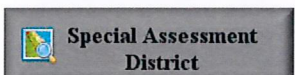
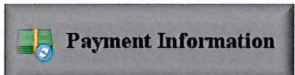

The Washoe County Treasurer's Office makes every effort to produce and publish the most current and accurate information possible. No warranties, expressed or implied, are provided for the data herein, its use, or its interpretation. If you have any questions, please contact us at (775) 328-2510 or tax@washoecounty.us

This site is best viewed using Google Chrome, Internet Explorer 11, Mozilla Firefox or Safari.

Account Detail

[Back to Search Results](#)

[Change of Address](#)

[Print this Page](#)

Washoe County Parcel Information

Parcel ID	Status	Last Update
04603204	Active	11/15/2016 2:10:14 AM
Current Owner: BOULDER CREEK ENTERPRISES PO BOX 22330 CARSON CITY, NV 89721		SITUS: 3230 OPHIR HILL RD WCTY NV
Taxing District 4000	Geo CD:	
Legal Description Township 17 Section 34 Lot Block Range 19 SubdivisionName _UNSPECIFIED		

Tax Bill (Click on desired tax year for due dates and further details)

Tax Year	Net Tax	Total Paid	Penalty/Fees	Interest	Balance Due
2016	\$1,183.62	\$591.82	\$0.00	\$0.00	\$591.80
2015	\$1,181.26	\$1,181.26	\$0.00	\$0.00	\$0.00
2014	\$1,166.32	\$1,177.98	\$0.00	\$0.00	\$0.00
2013	\$1,159.28	\$1,159.28	\$0.00	\$0.00	\$0.00
2012	\$1,176.72	\$1,188.49	\$0.00	\$0.00	\$0.00
Total					\$591.80

Important Payment Information

- **ALERTS:** If your real property taxes are delinquent, the search results displayed may not reflect the correct amount owing. Please contact our office for the current amount due.
- For your convenience, online payment is available on this site. E-check payments are accepted without a fee. However, a service fee does apply for online credit card payments. See Payment Information for details.

Pay Online

Payments will be applied to the oldest charge first.

Select a payment option:

- Total Due \$591.80
 Oldest Due \$295.90
 Partial

[ADD TO CART](#)

\$0.00

Pay By Check

Please make checks payable to:
WASHOE COUNTY TREASURER

Mailing Address:
P.O. Box 30039
Reno, NV 89520-3039

Overnight Address:
1001 E. Ninth St., Ste D140
Reno, NV 89512-2845

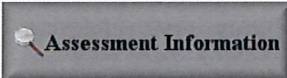
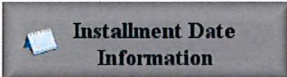
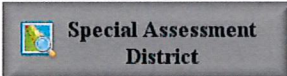
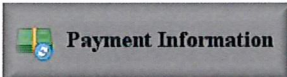

The Washoe County Treasurer's Office makes every effort to produce and publish the most current and accurate information possible. No warranties, expressed or implied, are provided for the data herein, its use, or its interpretation. If you have any questions, please contact us at (775) 328-2510 or tax@washoecounty.us

This site is best viewed using Google Chrome, Internet Explorer 11, Mozilla Firefox or Safari.

2 working days
before you
Call
DJs.

1-800-227-2600
AVOID CUTTING
UNDERGROUND UTILITIES

LINDA BURDICK OPHIR HILL SITE PLAN

APN: 046-032-02, 04, 05
NOVEMBER 2016

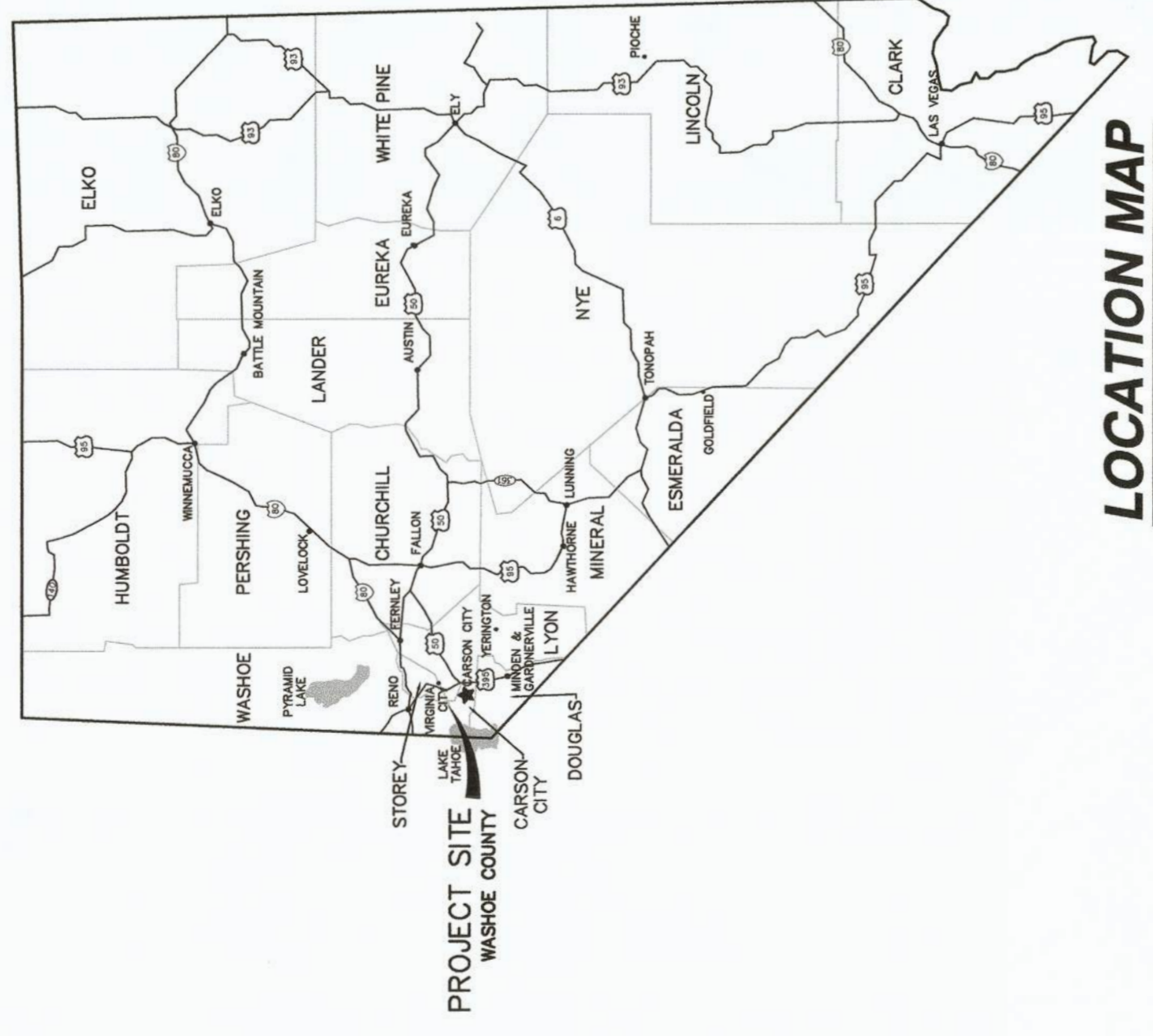

LOCATION MAP

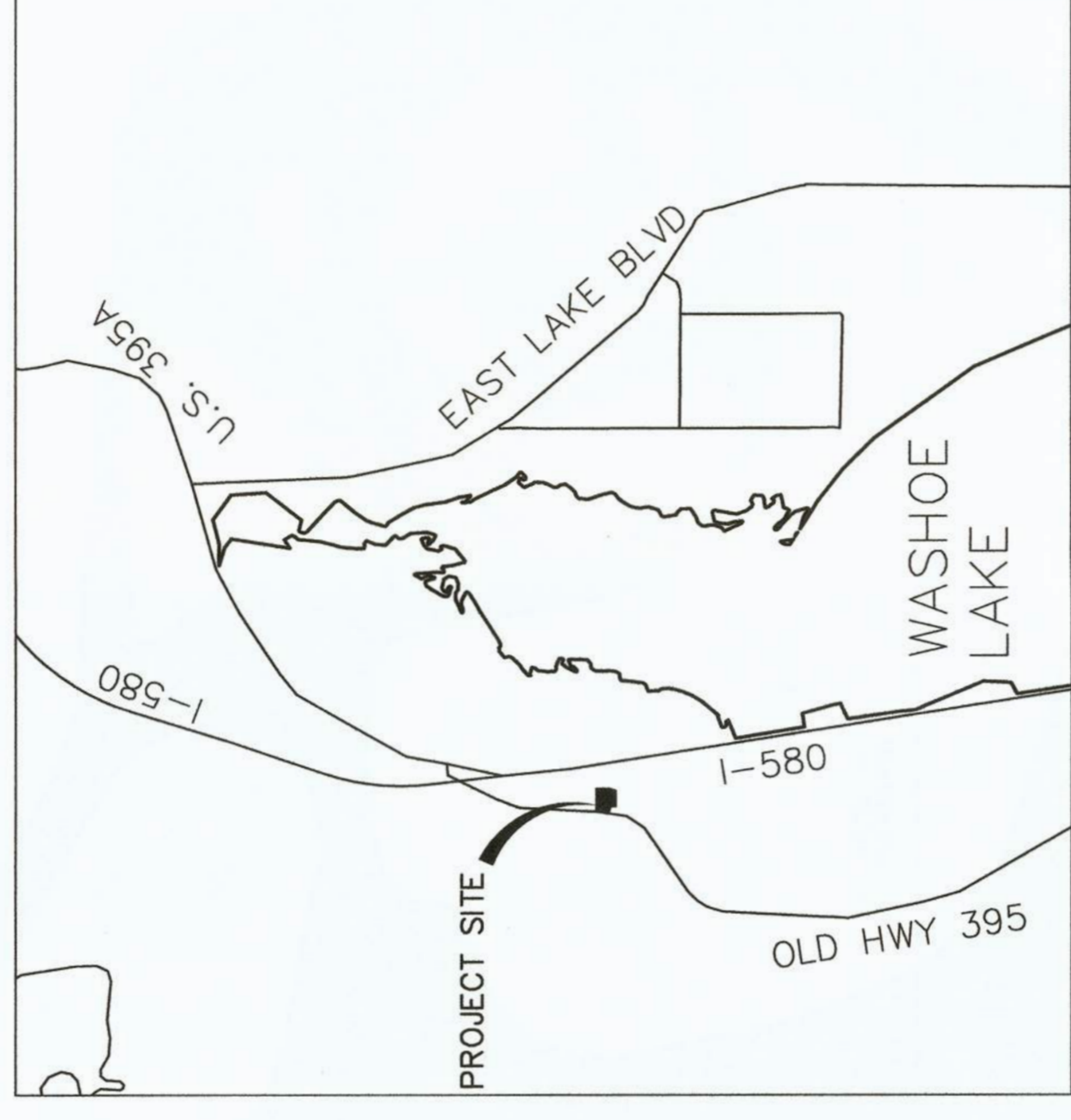

VICINITY MAP

OWNER/DEVELOPER:

LINDA BURDICK
PO BOX 22330
CARSON CITY, NV 89721
PH.: (775) 297-4566 EXT. 3
FAX: (775) 297-0974

ENGINEER



800 E. COLLEGE PARKWAY
CARSON CITY, NEVADA 89706
PH.: (775) 883-7077
FAX: (775) 883-7114

BASIS OF BEARING:

THE BASIS OF BEARINGS FOR THIS PROJECT IS N 39°12'12" E BEING THE PUBLISHED COORDINATES (NAD 83/94), NEVADA WEST OF WASHOE COUNTY, NEVADA, WHICH IS UNADJUSTED AND HAS A SCALE FACTOR OF 1.000197339.

BASIS OF ELEVATION:

DATUM: NAVD 88
PROJECT BENCHMARK = USCGS BENCHMARK J357 HAVING AN ELEVATION OF 5122.26'

SHEET INDEX:

TITLE SHEET	C1
EXISTING SITE PLAN	C2
GRADING/SITE PLAN	C3
BMP AND EROSION CONTROL PLAN	C4



800 E. COLLEGE PARKWAY
CARSON CITY, NEVADA 89706
TEL (775) 883-7077
FAX (775) 883-7114
WWW.LUMOSINC.COM

CIVIL ENGINEERING
GEOTECHNICAL ENGINEERING
PLANNING
LANDSCAPE ARCHITECTURE
SURVEYING/GIS
CONSTRUCTION SERVICES
MATERIALS TESTING



CLIENT	OPHIR HILL
INDEX SHEET	
WASHOE	
CARSON CITY	

BY	DESCRIPTION	REV	DATE

SUP SUBMITTAL

C1

DATE: 11/14/2016
DRAWN BY: JF
DESIGNED BY: JF
CHECKED BY: TR
JOB NO.: 9103.000



800 E. COLLEGE PARKWAY
 SUITE 200
 RENO, NV 89502
 TEL (775) 883-7077
 FAX (775) 883-7114
 WWW.LUMOSINC.COM

CIVIL ENGINEERING
 GEOTECHNICAL ENGINEERING
 PLANNING
 LANDSCAPE ARCHITECTURE
 SURVEYING
 CONSTRUCTION SERVICES
 MATERIALS TESTING



11-14-16

CARSON CITY, NV
 WASHOE
**OPHIR HILL
 EXISTING SITE AND
 TEMPORARY BMP PLAN**
 LINDA BURDICK

SUP SUBMITTAL

REV	DATE	DESCRIPTION	BY

C2

DATE: 11/14/2016
 DRAWN BY: JF
 DESIGNED BY: JF
 CHECKED BY: TR
 JOB NO.: 9103.000

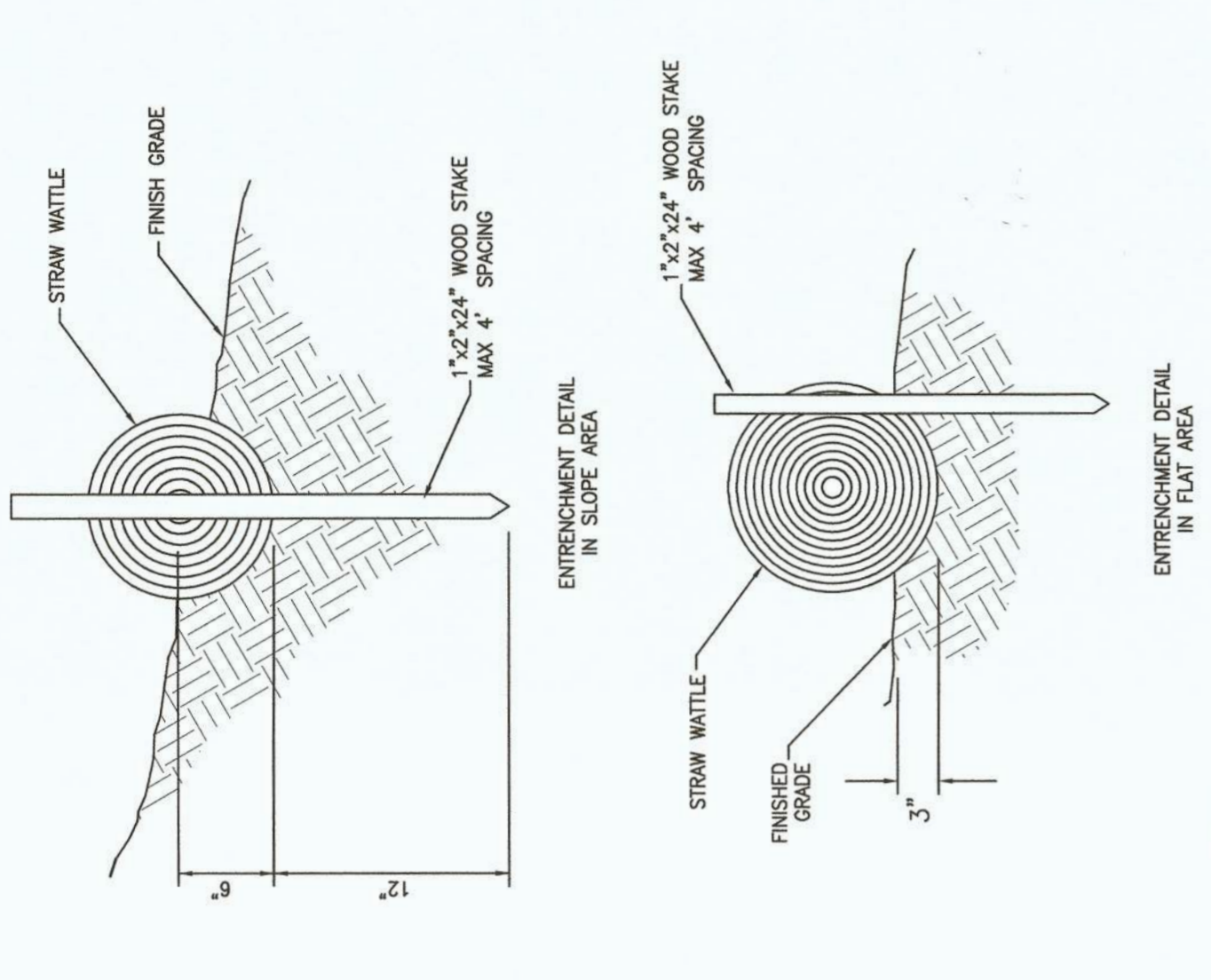

- NOTES:**
1. SEDIMENT ROLLS MAY BE FIBER ROLL LOGS OR RICE STRAW WATTLES. THEY SHALL BE A MINIMUM OF 16" IN DIAMETER WHEN PLACED ON SOIL. IF PLACED ON ASPHALT OR CONCRETE PAVING SHALL BE WEIGHTED AND SHALL BE A MINIMUM OF 8" IN DIAMETER.
 2. ROLLS SHALL BE INSTALLED PER THE MANUFACTURER'S RECOMMENDATIONS, THESE DETAILS AND THE SPECIAL PROVISIONS.
 3. WHEN MORE THAN ONE FIBER ROLL IS PLACED IN A ROW, THE ROLLS SHALL BE TIGHTLY ADJUTED AND STAKED, NOT OVERLAPPED.

STRAW WATTLE
 N.T.S.

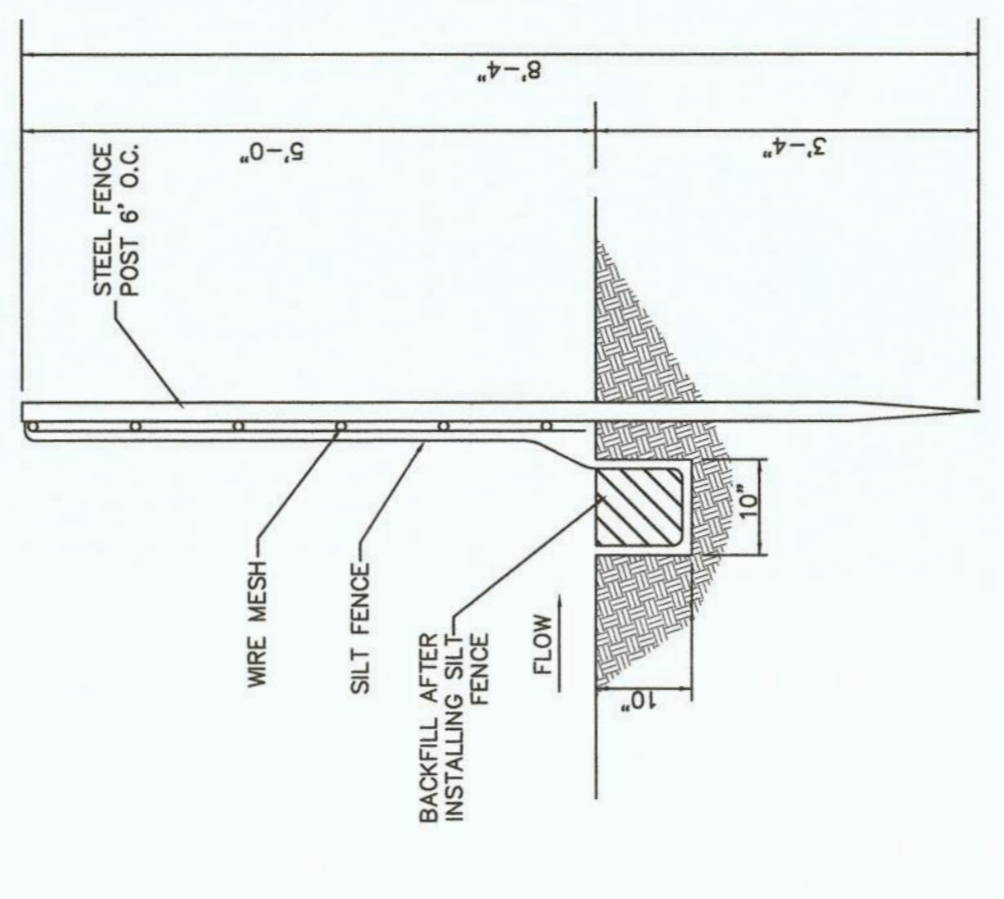

- NOTE:**
1. THE CONTRACTOR MAY USE MANUFACTURED SILT FENCING IN LIEU OF THE ABOVE, SUBJECT TO SUBMITTAL OF THE MANUFACTURER'S DATA SHEETS TO THE ENGINEER FOR APPROVAL.

EROSION CONTROL SILT FENCE
 N.T.S.

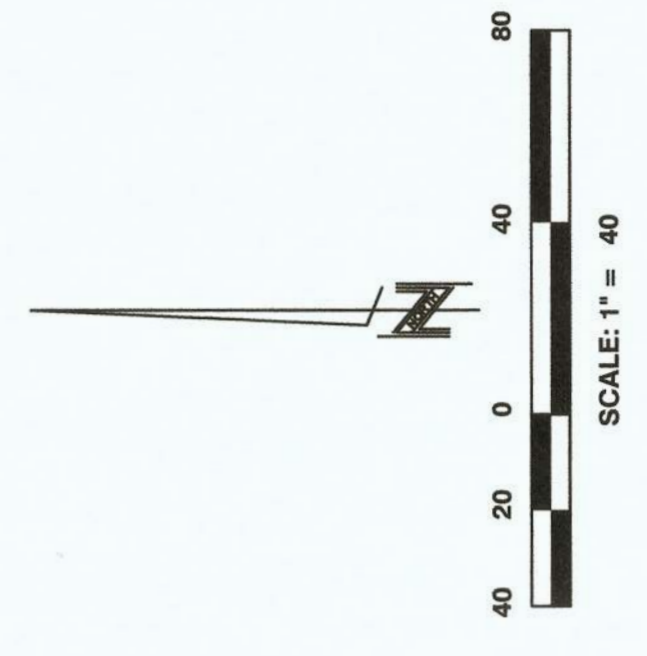
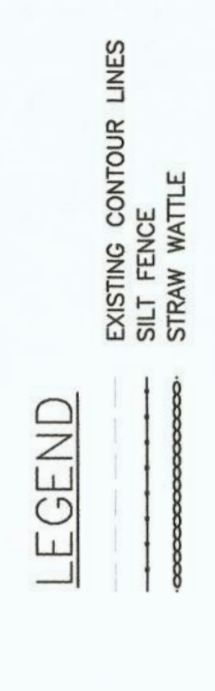

FALCON CAPITAL LLC
 APN: 046-022-04

FALCON CAPITAL LLC
 APN: 046-022-06



800 E. COLLEGE PARKWAY
CARSON CITY, NEVADA 89706
TEL (775) 883-7077
FAX (775) 883-7114

WWW.LUMOSINC.COM

CIVIL ENGINEERING
LANDSCAPE ARCHITECTURE
SURVEYING / GIS
CONSTRUCTION SERVICES
MATERIALS TESTING



11-14-16

OPHIR HILL
LINDA BURDICK
GRADING/SITE PLAN
WASHOE

REV	DATE	DESCRIPTION

C3

DATE: 11/14/2016
DRAWN BY: JF
DESIGNED BY: JF
CHECKED BY: TR
JOB NO.: 9103.000

NOTES:

- EXISTING DRAINAGE PATTERNS: OFFSITE, UP GRADIENT FLOWS ARE CAPTURED IN ROADSIDE DITCHES ALONG OLD US 395 AND CONVEYED TO A DRAINAGE CHANNEL NORTH OF THE SUBJECT PROPERTY. ONSITE FLOWS ARE CHARACTERIZED BY SHEET AND SUBSHEET DRAINAGE PATTERNS THAT DRAIN TO THE DRAINAGE CHANNEL AND OFFSITE TO AN EXISTING DRAINAGE CHANNEL EAST OF THE SUBJECT PROPERTY.
- PROPOSED DRAINAGE PATTERNS: TO RESTORE THE PROPERTY BACK TO ORIGINAL CONDITIONS, NO DRAINAGE CHANGES ARE PROPOSED. OFFSITE FLOWS WILL CONTINUE TO BE ROUTED TO THE NORTH OF THE PROPERTY AND ONSITE FLOWS WILL SHEET FLOW FROM WEST TO EAST AND EXIT THE PROPERTY AT THE EASTERN BOUNDARY.
- CUT AND FILL SLOPE SETBACKS DO NOT APPLY TO THE PROJECT AS THE SITE WILL BE RESTORED TO ITS ORIGINAL CONDITIONS WITH MILD SLOPES TYING INTO EXISTING GRADES AT THE PROPERTY BOUNDARIES.
- THERE ARE NO NATURAL AREAS WITH SLOPES GREATER THAN 15% AND 30% THE EXISTING SLOPES SHOWN ON THE PLANS ARE GENERALLY ROCK AND AGGREGATE PILES THAT WILL BE REMOVED.
- THERE ARE NO CRITICAL OR SENSITIVE BUFFER ZONES WITHIN THE PROPERTY BOUNDARIES IN ACCORDANCE WITH ARTICLE 418 OF THE WASHOE COUNTY DEVELOPMENT CODE.
- AS SHOWN IN THE EXCAVATION QUANTITIES TABLE BELOW, GRADING WILL RESULT IN A NET CUT OF APPROXIMATELY 110 CY. WITH THE CONTINUED OPERATIONS OF THE FACILITY, IT IS ANTICIPATED THAT CUSTOMERS WILL CONTINUE TO GATHER THE MATERIAL RESULTING IN A REDUCTION IN THE NET CUT CALCULATED. ANY UNUSED MATERIAL IS STRATEGICALLY PLACED WITHIN THE PARCELS TO CREATE A NATURAL APPEARANCE.

QUANTITIES TABLE	
DISTURBANCE	416,560 SF
CUT	18,472 CY
FILL	18,362 CY
NET	110 CY (CUT)

- LEGEND
- EXISTING CONTOUR LINES
 - PROPOSED CONTOUR LINES
 - LIMITS OF DISTURBANCE
 - PARCEL BOUNDARY
 - AGGREGATE BASE ACCESS ROAD

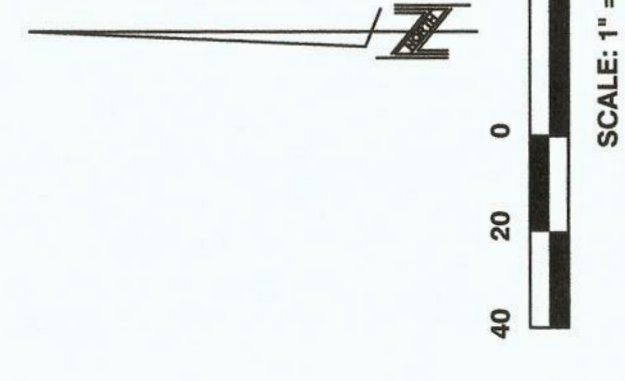



800 E. COLLEGE PARKWAY
CARSON CITY, NEVADA 89706
TEL (775) 883-7077
FAX (775) 883-7114

WWW.LUMOSINC.COM
CIVIL ENGINEERING
GEO-TECHNICAL ENGINEERING
LANDSCAPE ARCHITECTURE
SURVEYING / GIS
CONSTRUCTION SERVICES
MATERIALS TESTING



1/14/16

OPHIR HILL
LINDA BURDICK

BMP AND EROSION CONTROL PLAN

REV	DATE	DESCRIPTION

SUP SUBMITTAL

C4

DATE: 11/14/2016
DRAWN BY: JF
DESIGNED BY: JF
CHECKED BY: TR
JOB NO.: 9103.000

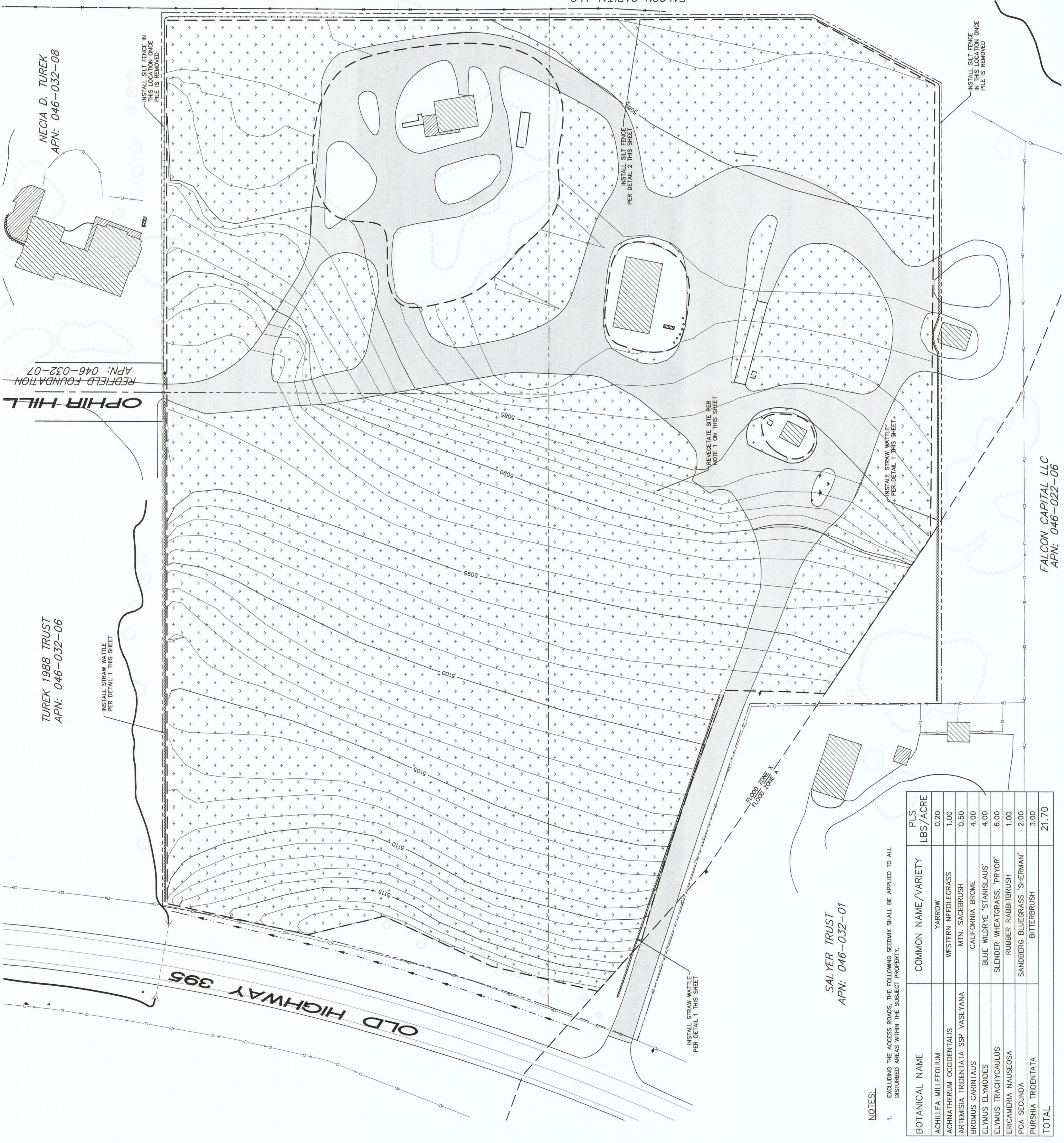

NECIA D. TUREK
APN: 046-032-08

REDFIELD FOUNDATION
APN: 046-032-07

OPHIR HILL

TUREK 1988 TRUST
APN: 046-032-06

INSTALL STRAW WATTLE
PER DETAIL 1 THIS SHEET

INSTALL SILT FENCE IN
THIS LOCATION ONCE
PILE IS REMOVED

FALCON CAPITAL LLC
APN: 046-022-04

INSTALL SILT FENCE
PER DETAIL 2 THIS SHEET

REVEGETATE SITE PER
NOTE 1 ON THIS SHEET

INSTALL STRAW WATTLE
PER DETAIL 1 THIS SHEET

INSTALL SILT FENCE
IN THIS LOCATION ONCE
PILE IS REMOVED

FALCON CAPITAL LLC
APN: 046-022-06

SALYER TRUST
APN: 046-032-01

NOTES:

- EXCLUDING THE ACCESS ROADS, THE FOLLOWING SEEDMIX SHALL BE APPLIED TO ALL DISTURBED AREAS WITHIN THE SUBJECT PROPERTY.

BOTANICAL NAME	COMMON NAME / VARIETY	PLS LBS/ACRE
ACHILLEA MILLEFOLIUM	YARROW	0.20
ACHNATHERUM OCCIDENTALIS	WESTERN NEEDLEGRASS	1.00
ARTEMISIA TRIDENTATA SSP VASEYANA	MTN. SAGEBRUSH	0.50
BROMUS CARINATUS	CALIFORNIA BROME	4.00
ELYMUS ELYMIOIDES	BLUE WILDRYE 'STANISLAUS'	4.00
ELYMUS TRACHYCALCULUS	SLENDER WHEATGRASS, 'PRYOR'	6.00
ERICAMERIA NAUSEOSA	RUBBER RABBITBRUSH	1.00
POA SECUNDA	SANDBERG BLUEGRASS 'SHERMAN'	2.00
PURSHIA TRIDENTATA	BITTERBRUSH	3.00
TOTAL		21.70

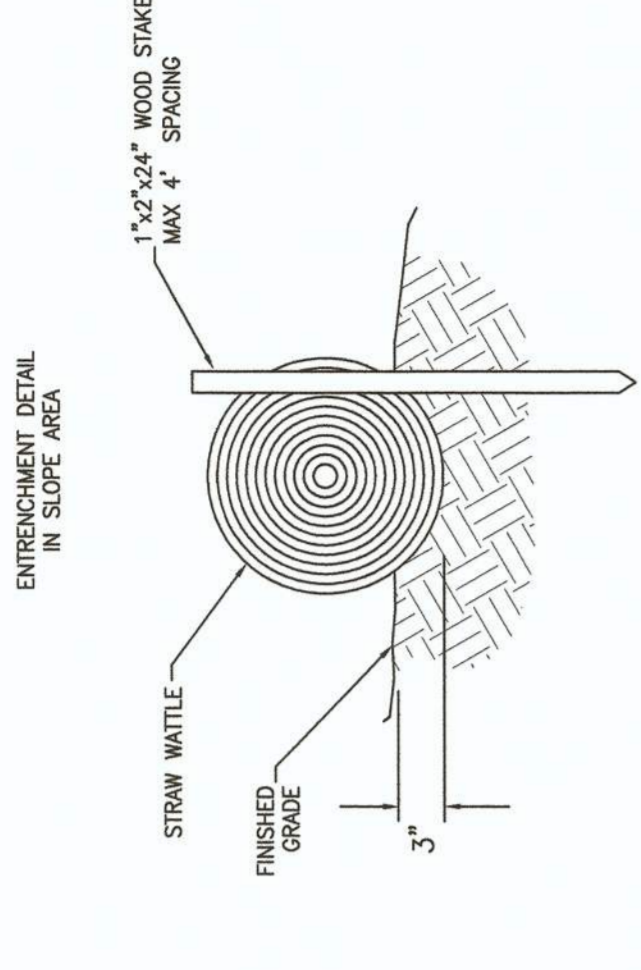
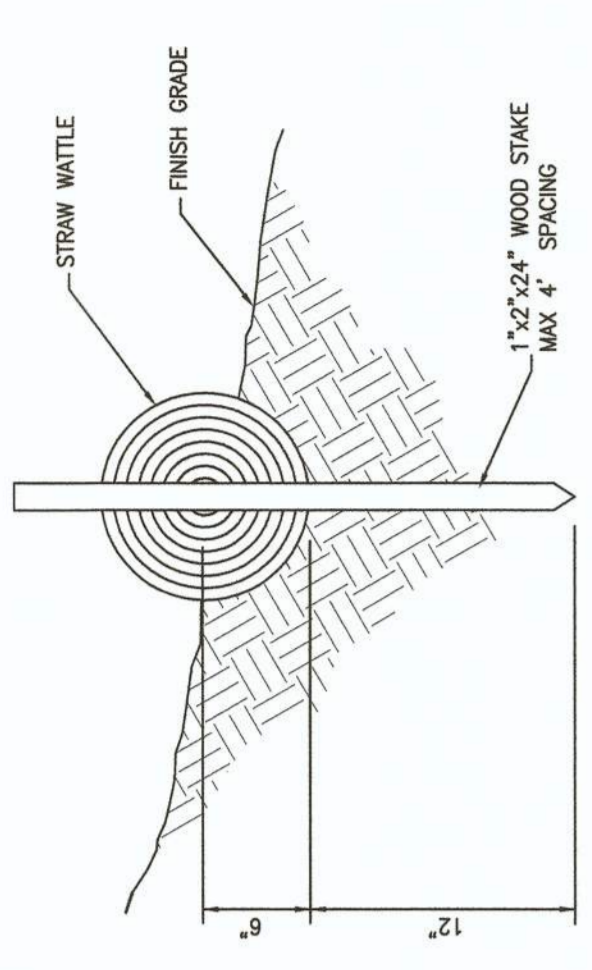

- NOTES:
- SEDIMENT ROLLS MAY BE FIBER ROLL LOGS OR RICE STRAW WATTLES. SEDIMENT ROLLS MUST BE PLACED ON AC PAVING SHALL BE WEIGHED AND SHALL BE A MINIMUM OF 8" IN DIAMETER.
 - ROLLS SHALL BE INSTALLED PER THE MANUFACTURER'S RECOMMENDATIONS. THESE DETAILS AND THE SPECIAL PROVISIONS.
 - WHEN MORE THAN ONE FIBER ROLL IS PLACED IN A ROW, THE ROLLS SHALL BE TIGHTLY ADJUTED AND STAKED, NOT OVERLAPPED.

STRAW WATTLE
N.T.S.

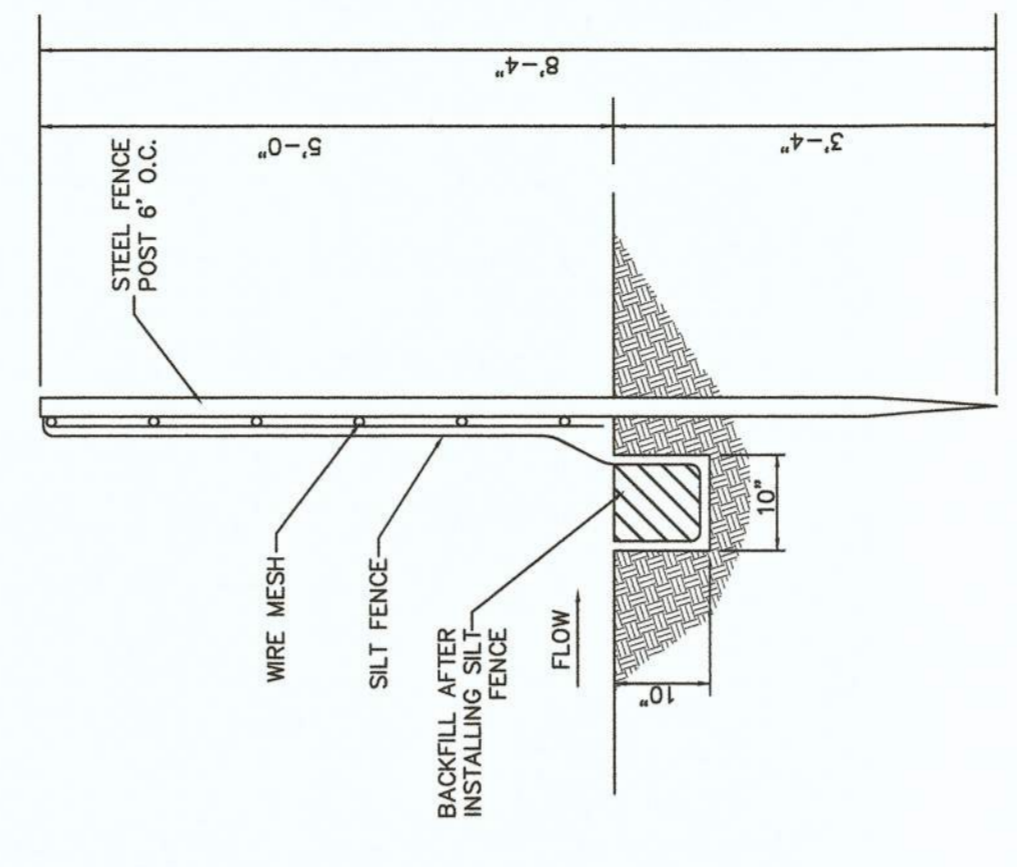

- NOTE:
- THE CONTRACTOR MAY USE MANUFACTURED SILT FENCING IN LIEU OF THE ABOVE, SUBJECT TO SUBMITTAL OF THE MANUFACTURER'S DATA SHEETS TO THE ENGINEER FOR APPROVAL.

EROSION CONTROL SILT FENCE
N.T.S.

LEGEND

	EXISTING CONTOUR LINES
	SILT FENCE
	STRAW WATTLE
	EROSION CONTROL
	PARCEL BOUNDARY
	AGGREGATE BASE ACCESS ROAD
	REVEGETATION AREAS





EXCAVATING COMPANY
P.O. Box 22330 Carson City, NV 89721
V: 775.297.4566 F: 775.297.0974

8/26/16

TO: WASHOE COUNTY Community Services Department
ATTN: Lora Barretta, Code Enforcement Officer II

RE: Case No. **C160011**

Property located at: 3230 & 3270 Ophir Hill Rod/632 US HWY 395 S
Parcel Number: 04603205; 04603204; 04603202

PLAN FOR COMPLIANCE

Boulder Creek Enterprises and Burdick Excavating Co., Inc., collectively referred to as "Burdick" submit the following plan which describes how the NOTICE OF BUSINESS LICENSE VIOLATION will be addressed:

1. Burdick will not conduct any business activity from the properties identified in the Notice.
2. Burdick will comply with the TRUCKEE MEADOWS REGIONAL STORMWATER QUALITY MANAGEMENT PROGRAM, including submitting required documents as required.
3. The properties identified in the Notice were buried by materials from a landslide originating from Slide Mountain to the northwest of the properties. It is estimated that the landslide deposited approximately 160,000 cubic yards of material on the properties. Burdick removed materials yearly in an attempt to get to the original grade of the property. The initial operation included separating the materials into like sizes for use on environmental projects. Burdick will continue to remove the remaining materials, but is faced with the challenge of where to take them.

The quantity of nonnative materials remaining on the properties is estimated to be 21,000 cubic yards.. An overhead view of the properties is included with this Plan. It illustrates the quantity, and types of materials that are currently remaining on the property.

The remaining 21,000 cubic yards of material will be removed by Burdick, but requires a period of **no more than ten (10) years to do so**. This time frame may be reduced, depending on the demand for these materials required for jobs undertaken primarily by Burdick Excavating Co., Inc., predominantly for Washoe County and the State of Nevada, for the Lake Tahoe basin environmental projects to improve water quality.

Once the non-native materials from the landslide are removed and the properties restored the original grade, Burdick hopes to subdivide the properties consistent with the applicable zoning; at present that is HDR.

Respectfully submitted, by Linda Burdick, President

WSUP16-0001
EXHIBIT E



Google earth

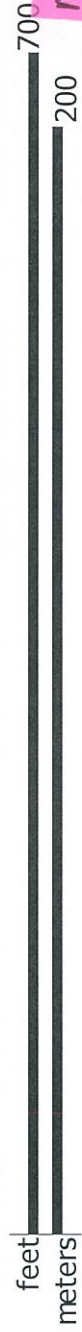

Google earth

Miso Piles
3,000 cy

11/28/16

AS
10
11/28/16

To: Property Owners within 500' of 3270 Old Hwy 395 N, and Ophir Hill Road

From: Burdick Excavating Co Inc. and Boulder Creek Enterprises (775-297-4566)

RE: Restoration of parcels effected by the 1983 Slide Mountain avalanche at 3270 Old Hwy 395 N and Ophir Hill Road

Washoe County has advised us that a Special Use Permit has expired and needs to be renewed, followed by a Grading Permit, in order to continue to restore the parcels to pre-landslide condition

As you are no doubt aware, in 1983 we experienced a major landslide that deposited approximately 160,000 cubic yards of rock and dirt materials on the three parcels. They have requested the following issues be outlined to adjacent property owners

- i. **Outline of proposed compliance plan-** We have conducted an aerial topo, and are currently developing a grading plan with Lumos & Associates to remove the majority of the rock material, and essentially grade out the 12 acres to an aesthetically pleasing contour, utilizing the decomposed granite material, and landscape boulders placed throughout. The base rock will be utilized onsite for traffic routes on the site.
- ii. **Proposed time frame for compliance-** Washoe County has requested that we complete the restoration within four years.
- iii. **Provide contact information at Washoe County** - If you have concerns or issues, the contact at Washoe County is: plncntr@washoecounty.us, or 775-328-6100 prior to 12/15/16.

It might be of interest to you, that the rock and dirt materials have been utilized in dozens of water quality projects in the Tahoe basin, many within Washoe County, as well as other counties. Many of the projects we have built around the Lake Tahoe basin have received awards for excellence from the TRPA, so the materials have been improving the environment significantly.

Also, there will be no increase in the activity on our parcels in order to accomplish this task within the time frame allocated.

Turek 1988 Trust
APN: 046-032-06
3210 Ophir Hill Rd
Washoe Valley, NV 89704

Timothy Salyer 2000 Trust
APN: 046-032-01
3280 Old Hwy 395 N
Washoe Valley, NV 89704

Turek 1988 Trust
APN: 046-032-08
3210 Ophir Hill Rd
Washoe Valley, NV 89704

Jay Rhodes
APN: 046-032-10
3200 Old Hwy 395 N
Washoe Valley, NV 89704

Coleman Holdings LTD PTSWP
APN: 046-032-09
PO Box 10528
Reno, NV 89510

John Helmer
APN: 046-031-50
3227 Old Hwy 395 N
Washoe Valley, NV 89704

Toral Family Trust
APN: 1730 La Mirada Ct
Carson City, NV 89703

Bundy-Nappe 2009 Trust
APN: 046-031-20
615 Robinson Ct
Reno, NV 89503

Bundy-Nappe 2009 Trust
APN: 046-031-21
615 Robinson Ct
Reno, NV 89503

PORTION OF THE EAST 1/2 OF SECTION 34
T17N - R19E

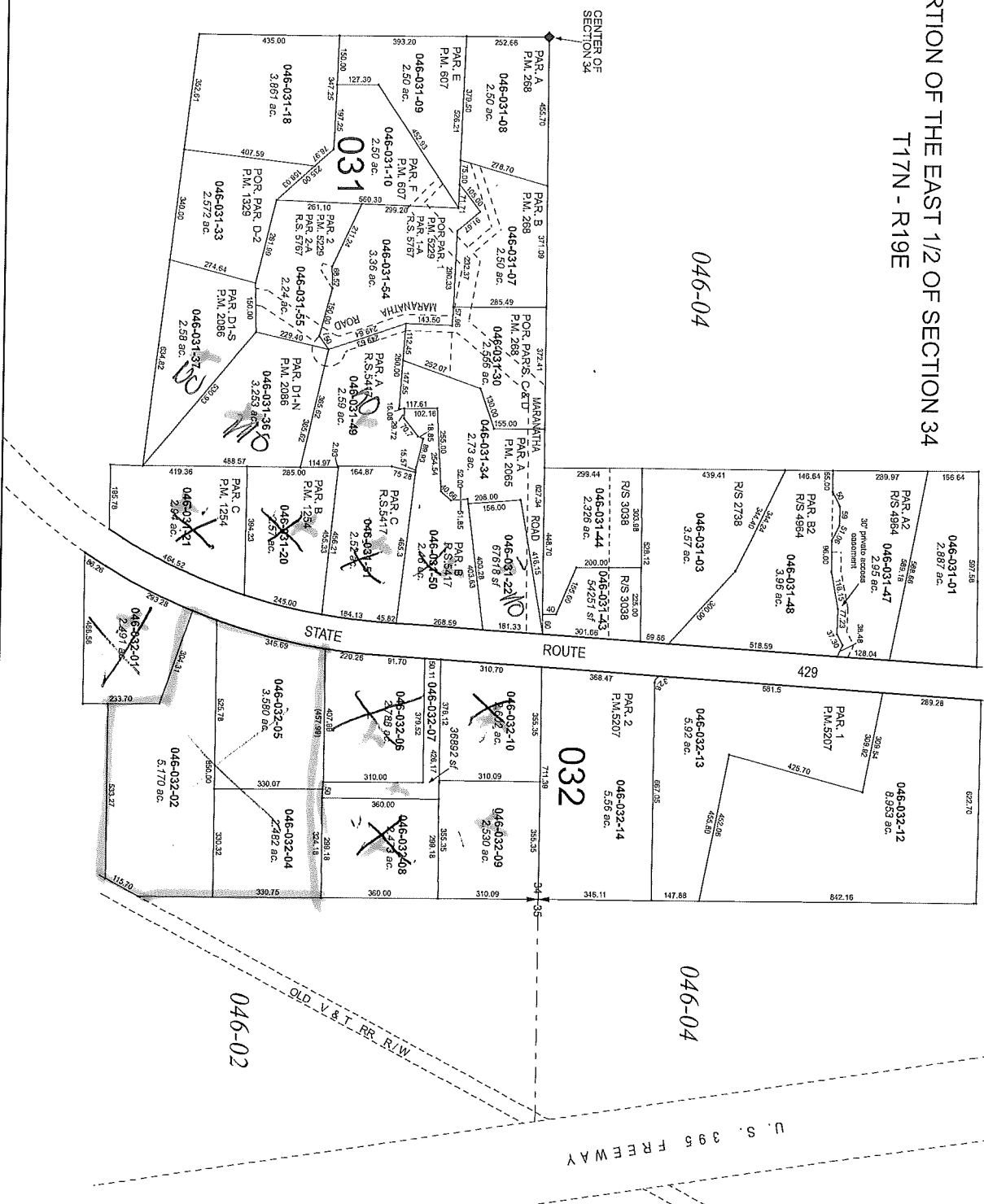

Assessor's Map Number
046-03

STATE OF NEVADA
WASHOE COUNTY
ASSESSOR'S OFFICE
Michael E. Clark, Assessor
1001 East Main Street
Building D
Reno, Nevada 89512
(775) 328-2251

WSUP16-0001
EXHIBIT F

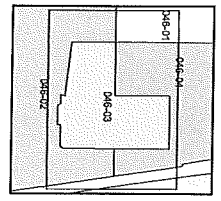
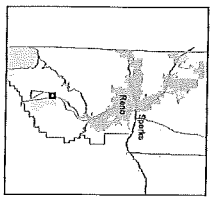
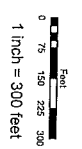

created by: **OFB 03/19/2012**
last updated: **EMG 5/5/16, SEB 09/26/16**
area previously shown on map(s)

NOTE: This map was prepared for the use of the Assessor's Office. It is not intended to be a survey of the premises. No liability is assumed for errors or omissions or for any other damages, direct or indirect, resulting from the use of this map.

APN: 046-031-21 Card 1 of 1

Owner Information & Legal Description	
Situs	0 UNSPECIFIED
Owner 1	BUNDY-NAPPE 2009 TRUST, LEONTINE
Mail Address	615 ROBINSON CT RENO NV 89503

PN: 046-031-20 Card 1 of 1

Owner Information & Legal Description	
Situs	0 UNSPECIFIED
Owner 1	BUNDY-NAPPE 2009 TRUST, LEONTINE
Mail Address	615 ROBINSON CT RENO NV 89503

APN: 046-031-51 Card 1 of 1

Owner Information & Legal Description	
Situs	UNSPECIFIED
Owner 1	TORAL FAMILY TRUST
Mail Address	1730 LA MIRADA CT CARSON CITY NV 89703

APN: 046-031-50 Card 1 of 2 Next Card

Owner Information & Legal Description	
(add'l) Situs	3227 OLD US 395
Owner 1	HELMER, JOHN
Mail Address	3227 OLD US HIGHWAY 395 N WASHOE VALLEY NV 89704

APN: 046-032-06 Card 1 of 1

Owner Information & Legal Description

Situs	3220 US HIGHWAY 395 S
Owner 1	TUREK 1988 TRUST
Mail Address	3210 OPHIR HILL RD WASHOE VALLEY NV 89704

PN: 046-032-01 Card 1 of 2 Next Card

Owner Information & Legal Description

(add'l) Situs	3280 OLD US 395
Owner 1	SALYER 2000 TRUST, TIMOTHY D
Mail Address	3280 OLD US HIGHWAY 395 N WASHOE VALLEY NV 89704

APN: 046-032-08 Card 1 of 1

Owner Information & Legal Description

Situs	3210 OPHIR HILL RD
Owner 1	TUREK 1988 TRUST
Mail Address	3210 OPHIR HILL RD WASHOE VALLEY NV 89704

APN: 046-032-10 Card 1 of 1

Owner Information & Legal Description

Situs	3200 OLD US 395
Owner 1	RHODES, JAY
Mail Address	3200 OLD US HIGHWAY 395 N WASHOE VALLEY NV 89704

APN: 046-032-09 Card 1 of 1

Owner Information & Legal Description

Situs	3190 OPHIR HILL RD
Owner 1	COLEMAN HOLDINGS LTD PTSP
Mail Address	PO BOX 10528 RENO NV 89510

Tina Nappe

615 Robinson Court, Reno, NV 89503

1178
775-786-7728
T.NAPPE@UNIVERSAL.NET

December 1, 2016

Burdick Excavating Co., Inc.
PO Box 22330
Carson City, NV 89721

Dear Burdick Excavating Co., Inc.

Re: Regarding Properties owned by Leontine Bundy-Nappe and Molly Toral specifically parcels, 04603120, 04603121, and 04603151 in Washoe Valley along Ophir Creek along old Highway 395.

You have announced that you plan to remove sand deposits left by the 1983 flood on our properties. In the meantime, my mother, the original owner has died and we have no knowledge of your interest in this property. If you have some reason to assume that you can utilize the flood debris and only provide a notice of your action, please send me a copy of the document.

Nothing has been done on this property for 20 years or more. During that time vegetation has started to regrow on the land, a benefit for mule deer. My sister and I are not interested in your special use permit to utilize the material until we have met, signed a contract establishing the parameters of use, established a price for the removal, and agreed upon a monitoring system.

We want to talk to Washoe County first and find out what, if any, requirements exist.

Thank you for your notice.

Sincerely,

Tina Nappe

Leontine Bundy-Nappe (Tina)

12/5/16 Spoke w/ Tina - told not
her parcels - she OK w/ it